



astro

CATÁLOGO 2022
Edición II

GLOSARIO DE ACABADOS Y NOMENCLATURAS



TEMPERATURA DE COLOR (CT)

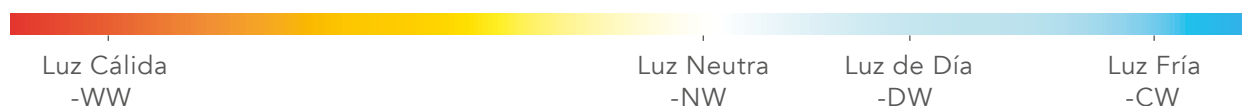

CT Temperatura de Color

WW Luz Cálida: (Entre 2700K y 3500K). Crea un ambiente íntimo y/o acogedor.

Es recomendable en tiendas de ropa, fruterías, panaderías y carnicerías. En viviendas se recomienda su instalación en sala, comedor y dormitorios.

NW Luz Neutra: (Entre 3800K y 4500K). Es la luz "más natural". Se puede instalar en cualquier entorno que no requiera del matiz específico que puedan aportar las otras 2 categorías.

DW Luz de Día: (5000K). Equivale a la luz de un día nublado.

CW Luz Fría: (6000K). Equivale a la luz de un día muy soleado. Genera una percepción de mayor luminosidad. Recomendada para oficinas, pescaderías y joyerías. En viviendas, es habitual encontrarlo en cocinas y baños.

CCT: (Temperatura de Color Correlacionada). Define la apariencia de color de un LED blanco. Se define en grados Kelvin. Las luminarias con esta característica permiten ir cambiando de tonos de color.

RGB: (Rojo, Verde, Azul). Las luminarias con LED RGB combinan estos tres colores para producir aprox. 16 millones de tonos de luz.

NIVEL DE PROTECCIÓN

- IP 44** Protección contra objetos sólidos mayores de 1mm y contra proyecciones de agua en todas direcciones.
- IP 54** Protección contra el polvo y contra proyecciones de agua en todas direcciones.
- IP 55** Protección contra el polvo y contra chorros de agua en todas direcciones.
- IP 65** Protección contra el polvo y contra fuertes chorros de agua en todas direcciones.
- IP 66** Protección contra el polvo y contra las pulverizaciones de agua con una presión de 1 bar a 3m.
- IP 67** Protección completa del polvo y contra los efectos de la inmersión. Es necesario que debajo del housing se haga un dren para desalojar 10 litros de agua en 5 minutos.
- IP 68** Protección completa del polvo y contra los efectos de la inmersión prolongada en agua profunda.

ACABADOS

- 01 Blanco
- 02 Satinado
- 03 Gris
- 04 Grafito
- 05 Bronce Rust
- 06 Cromo
- 07 Negro
- 08 Acero
- 09 ABZ
- 10 Yeso
- 11 Concreto
- 12 Aluminio

Nuestras luminarias cuentan con algunas de las mejores marcas de LED en el mercado:



*Nota: El color de la fotografía puede variar de acuerdo a la original debido a limitaciones inherentes al proceso fotográfico.

ÍNDICE REFERENCIAL

FOCOS LED 01 - 10

GYPSUM 11 - 15

DOWNLIGHTS 16 - 39

PROFESIONAL 40 - 57

CORTESÍA 58 - 66

OUTDOOR PARED 67 - 78

OUTDOOR PISO 79 - 88

SPIKE LIGHTS 89 - 92

SUBACUÁTICAS 93 - 96

BALIZAS 97 - 103

REFLECTORES 103 - 108

SISTEMAS RGB 109 - 116

INDUSTRIAL 117 - 121

URBANA 122-123

TIRAS LED 124 - 133

ACCESORIOS 134 - 138

ASTRO LTECH 139 - 147

ÍNDICE NUMÉRICO

00-2902-*	10	06-0325-*	32	07-0061-*	82	12-2815-*	49
00-2918-41	10	06-0326-*	33	07-0062-*	82	12-2825-*	49
00-2922-*	10	06-0329-*	33	07-0301-*	85	15-0050-65	122
03-4801-*	91	06-0409-*	31	07-0301-RGB	110	15-0100-65	122
03-4901-*	91	06-0512-*	31	07-0455-*	95	15-0150-65	122
04-1202-*	2	06-0718-*	30	07-07300-*	88	20-3110-50	119
04-1215-*	2	06-1070-*	26	07-07601-*	88	20-7100-50	119
05-0010-*	105	06-1090-*	26	07-1276-*	61	20-9080-40	118
05-0020-*	105	06-1224-*	30	07-1280-*	65	20-9080-65	118
05-0030-*	105	06-2011-*	55	07-1701-*	81	22-0128-*	20
05-0050-*	106	06-2012-*	23	07-1701-RGB	110	22-0210-*	120
05-0093-*	77	06-2283-*	18	07-1703-*	81	22-0218-*	20
05-0094-*	77	06-2314-*	25	07-1707-*	94	22-1216-*	56
05-0502-RGB	115	06-2315-*	25	07-2702-*	65	22-1232-*	56
05-0901-RGB	110	06-2489-*	18	07-2721-*	82	22-2060-*	55
05-1016-*	73	06-2901-*	36	07-30011-*	84	22-2073-*	72
05-1018-*	72	06-2904-*	36	07-30012-*	84	22-2409-*	46
05-1841-*	75	06-2905-*	36	07-30016-*	84	22-2815-*	50
05-2071-*	72	06-2906-*	36	07-30100-*	85	22-2825-*	50
05-2072-*	72	06-2907-*	37	07-4051-*	95	22-3002-*	48
05-2509-*	74	06-2910-*	37	07-40921-*	83	22-5031-*	70
05-2616-05	76	06-2911-*	37	07-40922-*	83	22-6136-*	55
05-2701-*	74	06-3108-*	24	07-40926-*	83	22-6503-*	45
05-2799-*	59	06-3110-*	24	07-4201-*	65	22-6504-*	45
05-2800-*	59	06-3117-*	24	07-6201-*	86	22-7133-*	71
05-2801-*	59	06-3125-*	24	07-62024-*	94	22-7161-*	68
05-2805-*	59	06-3155-*	17	07-62100-*	85	22-8401-*	9
05-2806-*	59	06-3198-*	17	07-6301-*	86	22-8402-*	9
05-2807-*	59	06-3199-*	17	07-6301-RGB	111	22-8404-*	9
05-3223-*	76	06-3210-*	33	07-6401-*	87	22-9036-*	22
05-3500-*	107	06-3211-*	34	07-6401-RGB	111	22-9051-*	69
05-3505-*	90	06-3212-*	34	07-7053-*	80	23-2815-*	50
05-5031-*	70	06-3213-*	34	07-7301-*	87	23-2825-*	50
05-5032-*	70	06-3254-*	17	07-9201-*	80	26-1340-*	44
05-7001-*	65	06-3901-*	38	08-0360-*	60	26-2601-*	42
05-7021-*	95	06-3902-*	38	08-1273-*	61	26-6640-*	43
05-7021-RGB	113	06-3903-*	38	08-1901-*	66	26-6640-CCT	43
05-7131-*	71	06-4401-*	19	08-2201-*	66	26-6675-50	44
05-7132-*	71	06-4402-*	19	08-2203-*	66	27-4001-40	120
05-7302-*	73	06-6313-*	25	08-3013-10	14	28-6640-50	42
05-7491-*	69	06-7010-*	41	08-7401-*	60	30-0412-*	7
05-7492-*	69	06-7091-*	41	08-7501-*	60	35-1005-*	4
05-7493-*	68	06-7092-*	41	08-8301-*	64	35-2703-*	4
05-7494-*	68	06-7095-*	41	08-8401-*	64	45-1004-*	5
05-7510-*	78	06-9033-10	22	08-8501-*	64	45-1204-*	4
05-8054-*	69	06-9034-*	22	08-9002-*	62	45-2604-*	6
05-8107-*	75	06-9035-*	22	08-9245-*	63	45-2704-*	6
05-8108-*	75	06-9129-10	13	10-1071-*	100	5-21101-*	108
05-9001-*	62	06-9130-10	13	10-1932-*	98	5-21101-RGB	116
05-9105-*	90	06-9131-10	13	10-2091-*	101	5-21201-*	108
05-9106-*	91	06-9224-10	14	10-2704-*	99	5-21201-RGB	116
05-9205-*	90	06-9229-10	13	10-9107-*	100	5-21301-*	108
05-9801-*	73	06-9285-10	14	11-1735-*	48	5-21301-RGB	116
06-0113-*	21	06-9442-10	14	11-2101-*	47	5-25100-*	106
06-0114-*	21	06-9703-10	15	11-2409-*	46	5-25250-*	107
06-0305-*	31	06-9703-D	15	11-2815-*	49	5-25400-*	106
06-0321-*	32	06-9703-I	15	11-2825-*	49	55-1933-*	98
06-0322-*	32	06-9703-TD	15	11-3001-*	47	55-2091-*	101
06-0323-*	32	06-9703-TI	15	11-5009-*	47	55-2301-*	99

ÍNDICE NUMÉRICO

55-2704-*	99	CON-F6-*	54	RGB-3600	146
55-2773-*	102	CON-L3-*	54	TR-0310-*	51
55-2775-*	102	CON-T4-*	54	TR-0320-*	51
55-4021-RGBW	114	CON-X5-*	54	TRA-12100	138
55-9107-*	100	CONL-221232-*	57	TRA-12200	138
6-12554-*	28	CONT-221232-*	57	TRA-1245	137
6-12654-*	28	DIM-D1	147	TRA-1250	137
6-21421-*	20	EBOX-AP	143	TRA-24100	138
6-21621-*	20	EBOX-TD	143	TRA-24200	138
6-21701-*	20	EX1S	142	TRA-2430	137
6-26752-RGB	110	EX2	142	TRA-2460	137
6-26951-*	26	EX4S	142	TRK-1000-*	53
6-26957-*	26	EX5	142	TRK-2000-*	53
6-27051-*	27	EX6	142	WiFi-106	143
6-28151-*	27	EX8S	142	XR-0362-*	52
6-29007-*	39	EXC1	142	XR-0364LL-*	52
6-29012-*	39	EXC2	142	XR-0364LR-*	52
6-51112-*	29	EXC3	142	XR-0364RL-*	52
6-52112-*	29	EXC4	142	XR-0364RR-*	52
6-53112-*	29	F4-5A	141	XR-0365-*	52
60-1007-*	5	F4-CC	141	XR-0366-*	52
60-1011-*	5	FB-43282-*	125	XR-0367-*	52
64-2706-*	6	FB-43528-*	124	XR-369L-*	52
66-3407-*	18	FB-72282-*	125	XR-369R-*	52
77-0306-*	96	FC-43286-*	130	XR-361L-*	52
77-0391-*	96	FE-43287-*	126	XR-361R-*	52
77-0393-RGB	113	FE-72287-*	126	XR-363L-*	52
77-2501-*	93	FS-0036-RGB	129	XR-363R-*	52
77-2503-*	93	FS-1036-RGB	130		
77-2506-*	93	FS-27352-*	131		
77-4703-*	94	FS-43285-*	127		
77-4703-RGB	113	FS-48356-TC	128		
77-6013-RGB	112	FS-96555-RGBW	129		
77-6015-RGB	112	FV-48110-*	131		
80-0903-*	2	K1	145		
80-0924-*	2	K2	145		
80-1015-*	8	M1+RGB-33A	146		
80-1112-*	8	M2+RGB-33A	146		
80-1205-*	3	M3-3A	146		
80-1603-RGB	3	M6+RGB-33A	146		
80-2003-*	7	M8+M4-5A	146		
80-2007-*	3	PS-12025	134		
80-2225-*	3	PS-12050	134		
80-3002-*	8	PS-12100	134		
81-0925-*	2	PS-12100-D	136		
86-1702-KIT-*	23	PS-12150	135		
90-2501-RGB	115	PS-12150-D	136		
90-3001-*	104	PS-12250	135		
90-3001-RGB	115	PS-24050	134		
90-3201-*	104	PS-24100	134		
90-3202-*	104	PS-24100-D	136		
97-06300-*	88	PS-24150	135		
97-06601-*	88	PS-24150-D	136		
AP-1616	132	PS-24250	135		
AP-2011	132	PS-24400	135		
AP-2507	132	REP-3040-5A	144		
AP-2811	132	REP-3060	144		
CON-221232	57	REP-3063	144		
CON-B2-*	54	REP-3070	144		



astro
LED Lighting

+10 años dedicados
a la iluminación arquitectónica

comprometidos a ofrecer productos lumínicos de vanguardia que ayuden
a transformar espacios en ambientes de bienestar y confort.

www.astroled.com.mx

FOCOS LED



FOCOS LED

G4 | G9

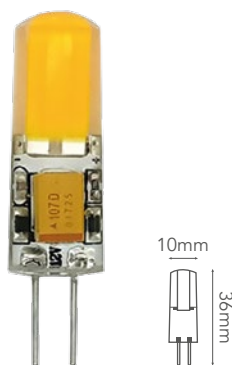

04-1202-WW



04-1215-WW



80-0924-*



81-0925-WW 



80-0903-*

Modelo	Base	Watts	CT	Lúmenes	LED	Apertura	Voltaje	CRI	IP	Material
04-1202-WW	G4	1.5W	3000K	180	COB	360°	12V AC/DC	>80	20	Tapa de Gel
04-1215-WW	G4	1W	3000K	120	SMD	360°	12V AC/DC	>80	20	Cristal
80-0924-*	G9	3.5W	3000K / 4000K	380	SMD	350°	90-130V AC	>80	20	Cerámica + PC
81-0925-WW	G9	4W	3000K	500	SMD	350°	90-130V AC	>80	20	Cerámica + PC 
80-0903-*	G9	4W	3000K / 4000K	360	SMD	90°	90-130V AC	>80	20	Cerámica + PC

GU5.3 | GU10

FOCOS LED



80-1205-*



80-2007-*

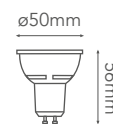

80-2225-*

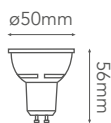

80-1603-RGB



*Incluido

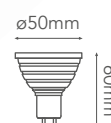

Modelo	Base	Bulbo	Watts	CT	Lúmenes	LED	Apertura	Voltaje	CRI	IP	Material
80-1205-*	GU5.3	MR16	5W	3000K / 4500K	400	SMD	38°	90-130V	>80	20	PC
80-2007-*	GU10	MR16	6.5W	3000K / 4000K	560	SMD	38°	90-130V	>80	20	PC
80-2225-*	GU10	MR16	5W	2700K / 3000K / 4000K / 6500K	400	SMD	38°	100-240V	>80	20	PC
80-1603-RGB	GU10	MR16	3W	RGB	40	COB	35°	100-120V	-	20	Aluminio

FOCOS LED

E12

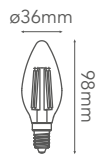

35-2703-WW

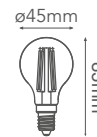

45-1204-WW

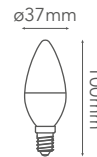

35-1005-*

Modelo	Base	Watts	CT	Lúmenes	LED	Apertura	Voltaje	CRI	IP	Material
35-2703-WW	E12	5W	2700K	600	Filamento	360°	110-130V	>80	20	Aluminio + Cristal
45-1204-WW	E12	5W	2700K	600	Filamento	360°	110-130V	>80	20	Aluminio + Cristal
35-1005-*	E12	4.5W	3000K / 5000K	340	SMD	180°	110-130V	>80	20	Aluminio + PC

E26

FOCOS LED

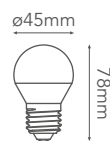

45-1004-*

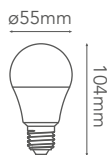

60-1007-*

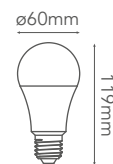

60-1011-*

Modelo	Base	Watts	CT	Lúmenes	LED	Apertura	Voltaje	CRI	IP	Material
45-1004-*	E26	4.5W	3000K / 4000K / 6000K	400	SMD	180°	110-130V	>80	20	Aluminio + PC
60-1007-*	E26	7W	3000K / 4000K / 6000K	560	SMD	270°	110-130V	>80	20	Aluminio + PC
60-1011-*	E26	11W	3000K / 4000K / 6000K	1050	SMD	270°	110-130V	>80	20	Aluminio + PC



45-2604-WW 



45-2704-WW



64-2706-WW 

Modelo	Base	Watts	CT	Lúmenes	LED	Apertura	Voltaje	CRI	IP	Material	
45-2604-WW	E26	5W	2700K	400	Filamento	360°	110-130V	>80	20	Aluminio + Cristal	
45-2704-WW	E26	4W	2700K	340	Filamento	360°	110-130V	>80	20	Aluminio + Cristal	
64-2706-WW	E26	5W	2700K	400	Filamento	360°	110-130V	>80	20	Aluminio + Cristal	

PAR20 | PAR30

FOCOS LED

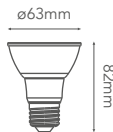

80-2003-*

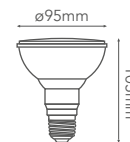

30-0412-WWW

Modelo	Base	Bulbo	Watts	CT	Lúmenes	LED	Apertura	Voltaje	CRI	IP	Material
80-2003-*	E26	PAR20	9W	3000K / 4000K	720	SMD	38°	100-240V	>80	20	Alum + PC
30-0412-WWW	E26	PAR30	12W	3000K	960	SMD	38°	100-240V	>80	20	Alum + PC



80-3002-*



80-1112-* | 80-1112-D 



80-1015-WW

Modelo	Base	Bulbo	Watts	CT	Lúmenes	LED	Apertura	Voltaje	CRI	IP	Material
80-3002-*	E26	PAR30	10W	3000K / 4000K	800	SMD	45°	85-265V	>80	20	Aluminio + PC
80-1112-*	AR111	AR111	12W	3000K / 4000K	960	COB	20°	90-240V	>80	20	Aluminio 
80-1015-WW	G53	AR111	13W	3000K	1200	SMD	24°	12V AC/DC	>80	20	Aluminio + PC

INTELE-TUBE

FOCOS LED



LED SMD 4014

ACCESORIOS:



CON-22840



CON-840

*Incluidos



CON-15840



CBL-22840

*Se venden por separado.



22-8401-*

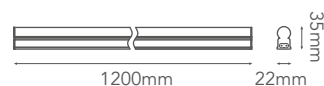

22-8402-*

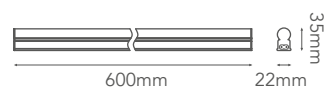

22-8404-*

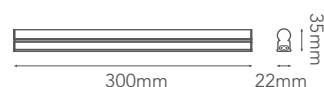

NOTA: Interconectable hasta 8 piezas. Sistema de Fijación incluido.

Modelo	Base	Watts	CT	Lúmenes	LED	Apertura	Voltaje	CRI	IP	Material
22-8401-*	T5	18W	3000K / 4500K	1980	SMD	120°	100-240V	>80	20	PC
22-8402-*	T5	9W	3000K / 4500K	1100	SMD	120°	100-240V	>80	20	PC
22-8404-*	T5	5W	3000K / 4500K	450	SMD	120°	100-240V	>80	20	PC



00-2902-*

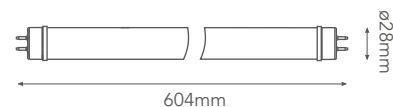

00-2922-*

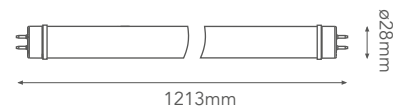

00-2918-41

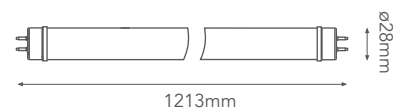

Características Especiales:

- *Cubierta de cristal 100% de aislamiento, más seguro, aspecto similar al tubo tradicional.
- *Aislamiento total entre los dos extremos - Una instalación más segura.
- *LED SMD 2835 - Este tipo de LED es más delgado, tiene una mejor disipación del calor, cuenta con un ángulo más amplio y es más brillante.
- *Última tecnología en diseño de driver. Alta eficiencia, voltaje de entrada universal, alto factor de potencia, menos calor, por tanto, menor desgaste y mejor tiempo de vida.
- *Estructura con diseño único para un fácil montaje e instalación.

Modelo	Base	Watts	CT	Lúmenes	LED	Apertura	Voltaje	CRI	IP	Material
00-2902-*	T8	10W	3000K / 4100K / 6000K	1000	SMD 2835	240°	100-240V	>80	20	Cristal + PET
00-2922-*	T8	18W	3000K / 4100K / 6000K	1800	SMD 2835	240°	100-240V	>80	20	Cristal + PET
00-2918-41	T8	18W	4100K	1800	SMD 2835	240°	100-277V	>80	20	Cristal + PET

GYPSUM



GYPSUM



Luminarios hechos a base de yeso, especialmente diseñados para colocar en plafones de tablaroca. Con un efecto final invisible que enriquece la atmósfera de cualquier habitación.

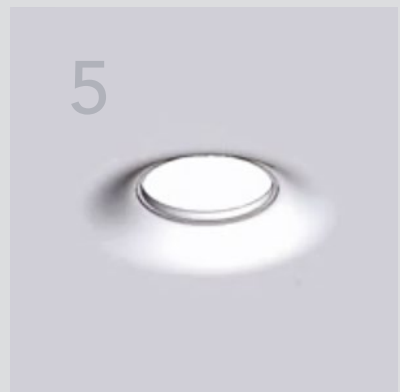
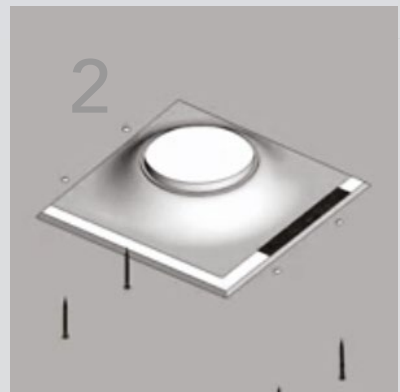

GYPSUM

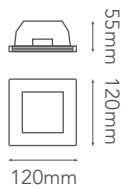

06-9129-10

-10 Yeso

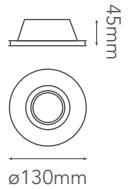

06-9130-10

-10 Yeso



06-9131-10

-10 Yeso

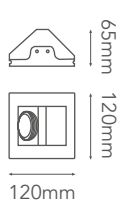

06-9229-10

-10 Yeso

NOTA: Soquet incluido. Foco se vende por separado.

Modelo	Base	Foco	Watts	Voltaje	IP	Material
06-9129-10	GU10	MR16	Máx. 12W	127V	20	Yeso
06-9130-10	GU10	MR16	Máx. 12W	127V	20	Yeso
06-9131-10	GU10	MR16	Máx. 12W	127V	20	Yeso
06-9229-10	GU10	MR16	Máx. 12W	127V	20	Yeso

GYPSUM

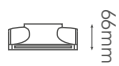

204mm

06-9224-10

-10 Yeso

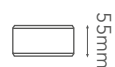

80mm

06-9285-10

-10 Yeso

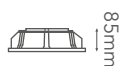

230mm

06-9442-10

-10 Yeso

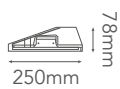

150mm

08-3013-10

-10 Yeso

NOTA: Soquet incluido. Foco se vende por separado.

Modelo	Base	Foco	Watts	Voltaje	IP	Material
06-9224-10	GU10	MR16	Máx. 12W	127V	20	Yeso
06-9285-10	GU10	MR16	Máx. 12W	127V	20	Yeso
06-9442-10	G53	AR11	Máx. 50W	12V / 127V	20	Yeso
08-3013-10	GU10	MR16	Máx. 12W	127V	20	Yeso

GYPSUM

*Para plafón de tablaroca 12mm

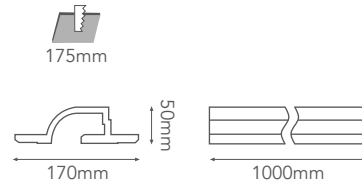

06-9703-10

-10 Yeso

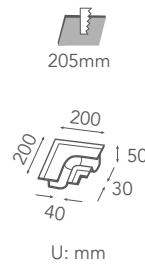

06-9703-D

-10 Yeso

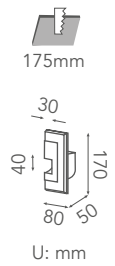

06-9703-TD

-10 Yeso

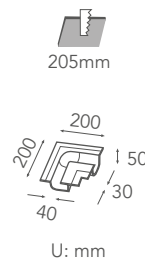

06-9703-I

-10 Yeso

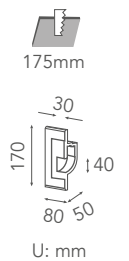

06-9703-TI

-10 Yeso

NOTA: Tira LED se vende por separado.

Modelo	Base	Voltaje	IP	Material
06-9703-10	Para tira de LED	127V	20	Yeso
06-9703-D	Para tira de LED	127V	20	Yeso
06-9703-I	Para tira de LED	127V	20	Yeso
06-9703-TD	Para tira de LED	127V	20	Yeso
06-9703-TI	Para tira de LED	127V	20	Yeso

DOWNLIGHTS

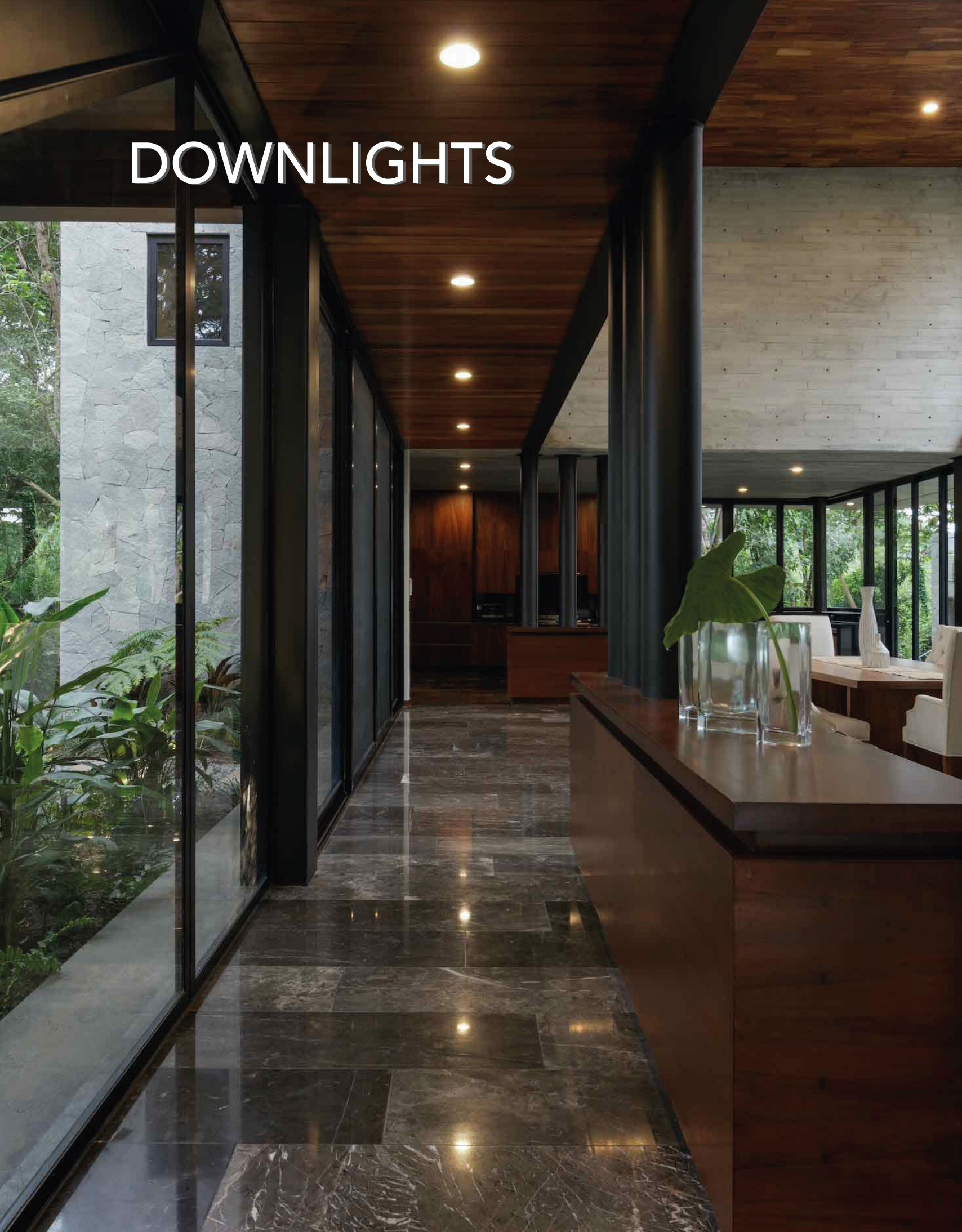

BASIC

DOWNLIGHTS



06-3155-*

-01 Blanco -02 Satinado -07 Negro

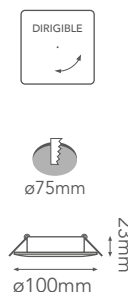

06-3254-*

-01 Blanco -02 Satinado -07 Negro



06-3198-*

-01 Blanco -07 Negro



06-3199-*

-01 Blanco -07 Negro

NOTA: Soquet incluido. Foco se vende por separado.

Modelo	Base	Foco	Watts	Voltaje	IP	Material
06-3155-*	GU10	MR16	Máx. 12W	127V	20	Aluminio
06-3254-*	GU10	MR16	Máx. 12W	127V	20	Aluminio
06-3198-*	GU10	MR16	Máx. 12W	127V	20	Aluminio
06-3199-*	GU10	MR16	Máx. 12W	127V	20	Aluminio

DOWNLIGHTS

BASIC



66-3407-*

-01 Blanco -06 Cromo

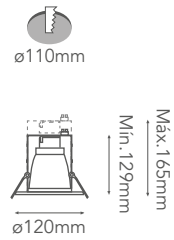

06-2283-*

-01 Blanco -02 Satinado

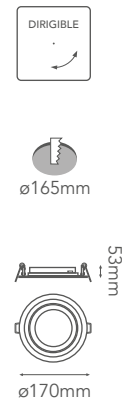

06-2489-*

-01 Blanco

NOTA: Soquet incluido. Foco se vende por separado.

Modelo	Base	Foco	Watts	Voltaje	IP	Material
66-3407-*	GU10	MR16	Máx. 12W	127V	65	Aluminio + Cristal
06-2283-*	E26	E26	Máx. 60W	127V	20	Aluminio + Cristal
06-2489-*	G53	AR111	Máx. 50W	127V	20	Aluminio

BASIC

DOWNLIGHTS

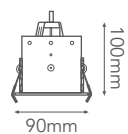

06-4401-*

-01 Blanco -03 Gris

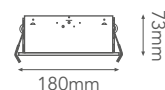

06-4402-*

-01 Blanco -03 Gris

NOTA: Soquet incluido. Foco se vende por separado.

Modelo	Base	Foco	Watts	Voltaje	IP	Material
06-4401-*	GU10	MR16	Máx.12W	127V	20	Aluminio
06-4402-*	GU5.3	MR16	Máx.12W	12V /127V	20	Aluminio + Acero

DOWNLIGHTS

PERSEIDA | CALYPSO

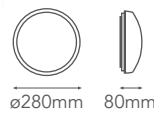

22-0128-NW

-01 Blanco

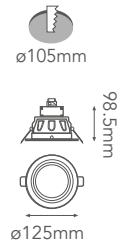

6-21701-*

-01 Blanco



6-21621-WW

-01 Blanco

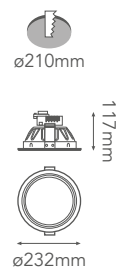

6-21421-*

-01 Blanco



NOTA: Driver incluido.

Modelo	Watts	CT	Lúmenes	LED	Apertura	Voltaje	CRI	IP	Material
22-0128-NW	12W	4000K	1020	SMD	120°	100-277V	>80	20	Aluminio + Plástico
6-21701-*	7W	3000K / 4000K	550	SMD 5630	90°	100-240V / 110V	>80	20	Aluminio
6-21621-WW	12W	3000K	950	SMD 5630	90°	100-240V / 110V	>80	20	Aluminio
6-21421-*	20W	3000K / 4000K	1650	SMD 5630	90°	100-240V / 110V	>80	20	Aluminio

CAMALEÓN II

DOWNLIGHTS

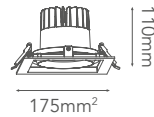

Accesorio
*Se vende por separado

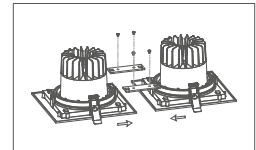

CON-060113
Conexión modular

06-0113-*

-01 Blanco -07 Negro

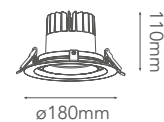

06-0114-*

-01 Blanco -07 Negro

NOTA: Driver TRIAC incluido.

Modelo	Watts	CT	Lúmenes	LED	Apertura	Voltaje	CRI	IP	PF	Material
06-0113-*	25W	3000K / 5000K	2600	COB	36°	120V / 110V	>80	20	0.9	Aluminio
06-0114-*	25W	3000K / 5000K	2600	COB	36°	120V / 110V	>80	20	0.9	Aluminio

DOWNLIGHTS

CÍCLOPE



06-9033-10

-10 Yeso



06-9034-*

-01 Blanco



06-9035-*

-01 Blanco



22-9036-*

-01 Blanco

Modelo	Watts	CT	Lúmenes	LED	Apertura	Voltaje	CRI	IP	Material
06-9033-10	11W	3000K	880	CREE PHILIPS	38°	90-130V	>80	20	Yeso
06-9034-*	13W	3000K	1040	CREE PHILIPS	38°	120V / 110V	>80	20	Aluminio 
06-9035-*	13W	3000K	1040	CREE PHILIPS	38°	90-130V	>80	20	Aluminio
22-9036-*	13W	3000K	856	CREE PHILIPS	38°	120V / 110V	>80	20	Aluminio 

CORAL | QUARK

DOWNLIGHTS



86-1702-KIT-*

-02 Satinado

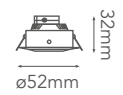

06-2012-*

-01 Blanco -02 Satinado

*Driver remoto incluido.

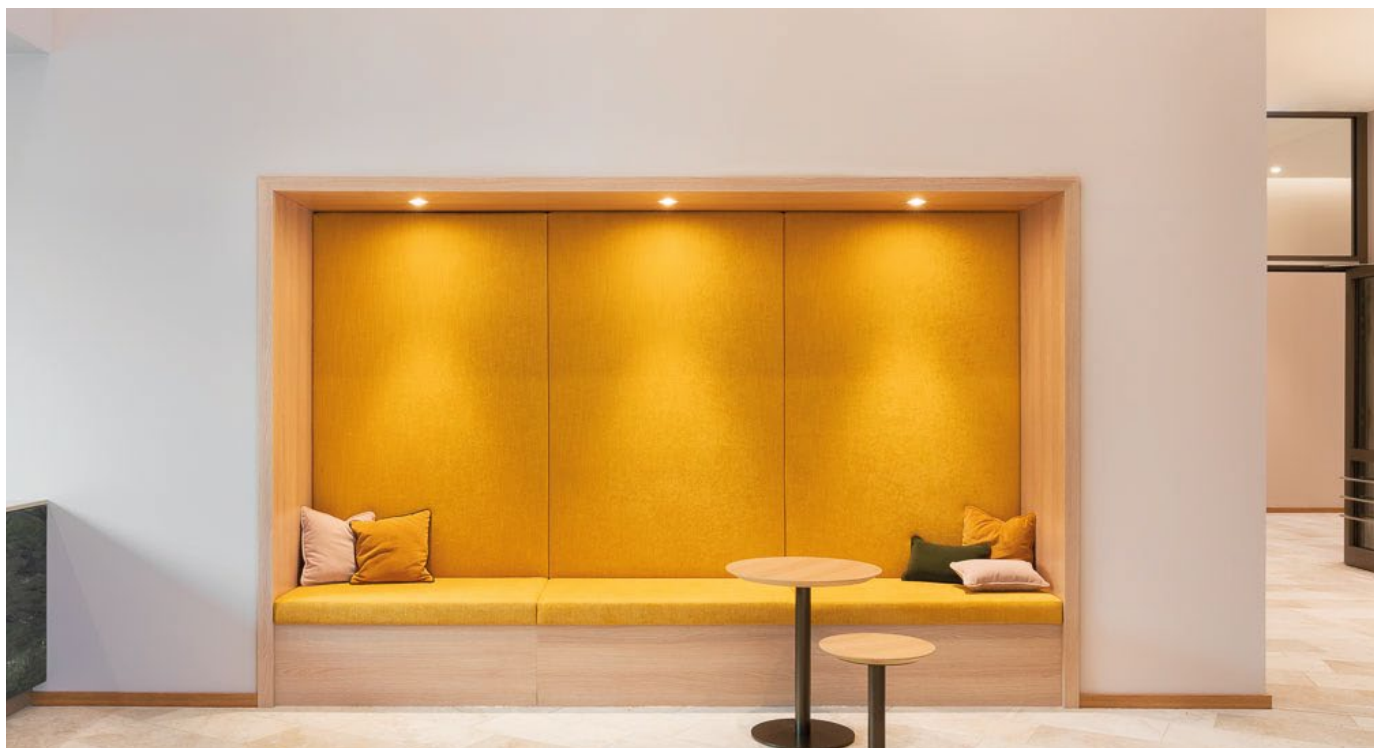

NOTA: Driver incluido.

Modelo	Watts	CT	Lúmenes	LED	Apertura	Voltaje	CRI	IP	Material
86-1702-KIT-*	3x1W	3000K / 4000K	3x68	CREE SMD	50°	127V	>80	20	PVC
06-2012-*	2.2W	3000K / 4000K	145	CREE SMD	40°	127V	>80	20	Aluminio

DOWNLIGHTS

NOVA II



06-3108-* | 06-3108-*D 

-01 Blanco -07 Negro



06-3110-* | 06-3110-*D 

-01 Blanco -07 Negro



06-3117-* | 06-3117-*D 

-01 Blanco -07 Negro











06-3125-* | 06-3125-*D 

-01 Blanco -07 Negro

*D = Dimeable

*NOVA acabado Negro -07 sólo disponible en versión Dimeable

Modelo	Watts	CT	Lúmens	LED	Apertura	Voltaje	CRI	IP	Material
06-3108-* 06-3108-*D	8W	3000K / 4100K	680	SMD	90°	100-277V	>80	20 / 44	Aluminio + Tapa plástica 
06-3108-07-*D	8W	3000K / 4100K	680	SMD	90°	100-277V	>80	20 / 44	Aluminio + Tapa plástica 
06-3110-* 06-3110-*D	12W	3000K / 4100K	1050	SMD	90°	100-277V	>80	20 / 44	Aluminio + Tapa plástica 
06-3110-07-*D	12W	3000K / 4100K	1050	SMD	90°	100-277V	>80	20 / 44	Aluminio + Tapa plástica 
06-3117-* 06-3117-*D	17W	3000K / 4100K	1670	SMD	90°	100-277V	>80	20 / 44	Aluminio + Tapa plástica 
06-3117-*	17W	3000K / 4100K	1670	SMD	90°	100-277V	>80	20 / 44	Aluminio + Tapa plástica 
06-3125-* 06-3125-*D	25W	3000K / 4100K	2230	SMD	90°	100-277V	>80	20 / 44	Aluminio + Tapa plástica 
06-3125-*	25W	3000K / 4100K	2230	SMD	90°	100-277V	>80	20 / 44	Aluminio + Tapa plástica 

MARS

DOWNLIGHTS

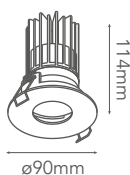

06-2314-WW



-01 Blanco -07 Negro

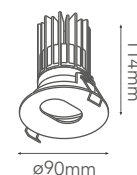

06-2315-WW



-01 Blanco -07 Negro



06-6313-WW

-01 Blanco

NOTA: Driver incluido.

Modelo	Watts	CT	Lúmenes	LED	Apertura	Voltaje	CRI	IP	Material
06-2314-WW	10W	3000K	660	SMD	24°	120-277V	>80	20	Aluminio
06-2315-WW	10W	3000K	750	SMD	24°	120-277V	>80	20	Aluminio
06-6313-WW	3W	3000K / 4000K	215	CREE XPE	40°	85-265V	>80	20	Aluminio

DOWNLIGHTS

MELODY | SKY

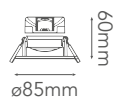

06-1070-*

-01 Blanco

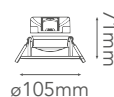

06-1090-*

-01 Blanco

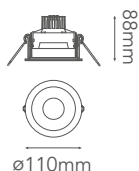

6-26951-*

-01 Blanco

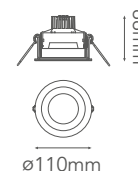

6-26957-NW

-01 Blanco

Modelo	Watts	CT	Lúmenes	LED	Apertura	Voltaje	CRI	IP	Material
06-1070-*	7W	3000K / 4000K	650	SMD	36°	100-265V	>80	20	Plástico + Alum
06-1090-*	10W	3000K / 4000K	950	SMD	36°	100-265V	>80	20	Plástico + Alum
6-26951-*	9W	3000K / 4000K	380	COB EPISTAR	25°	90-130V	>80	20	Aluminio
6-26957-NW	9W	4000K	698	COB EPISTAR	35°	110-240V	>80	20	Aluminio

SKY

DOWNLIGHTS

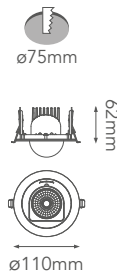

6-27051-NW | 6-27051-30D 

-01 Blanco



6-28151-NW | 6-28151-30D 

-01 Blanco

Modelo	Watts	CT	Lúmenes	LED	Apertura	Voltaje	CRI	IP	Material
6-27051-NW	9W	4000K	698	COB EPISTAR	18°	100-240V	>80	20	Aluminio
6-27051-30D	9W	3000K	698	COB EPISTAR	18°	100-240V	>80	20	Aluminio 
6-28151-NW	9W	4000K	600	COB EPISTAR	25°	90-240V	>80	20	Aluminio
6-28151-30D	9W	3000K	600	COB EPISTAR	25°	90-240V	>80	20	Aluminio 

DOWNLIGHTS

APOLO

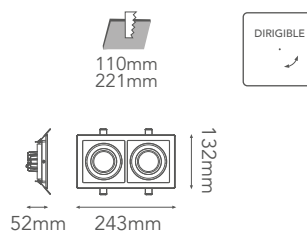

6-12554-* 

-01 Blanco -07 Negro

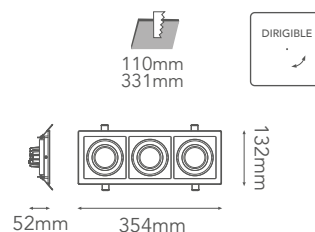

6-12654-*

-01 Blanco -07 Negro

Accesorio Dimmer ACT-26752-D
se vende por separado

Modelo	Watts	CT	Lúmenes	LED	Apertura	Voltaje	CRI	IP	Material
6-12554-*	18W	3000K / 4000K	1200	COB	24°	90-130V / 110V	>80	20	Aluminio 
6-12654-*	27W	3000K / 4000K	1800	COB	24°	90-130V	>80	20	Aluminio

HELIOS

DOWNLIGHTS

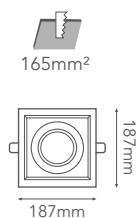

6-51112-*

-01 Blanco -07 Negro

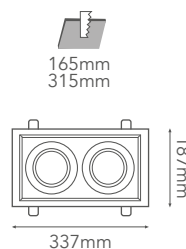

6-52112-*

-01 Blanco -07 Negro

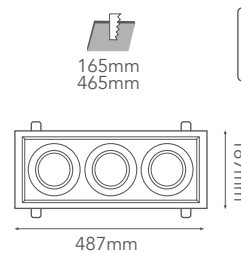

6-53112-*

-01 Blanco -07 Negro

NOTA: Focos incluidos. Opción de foco dimeable 80-1112-D, página 08, se vende por separado.

Modelo	Watts	CT	Lúmenes	LED	Apertura	Voltaje	CRI	IP	Material
6-51112-*	12W	3000K / 4000K	960	COB	24°	90-240V	>80	20	Aluminio + PMMA
6-52112-*	2x12W	3000K / 4000K	1920	COB	24°	90-240V	>80	20	Aluminio + PMMA
6-53112-*	3x12W	3000K / 4000K	2880	COB	24°	90-240V	>80	20	Aluminio + PMMA

DOWNLIGHTS

EQUINOX
Empotrados

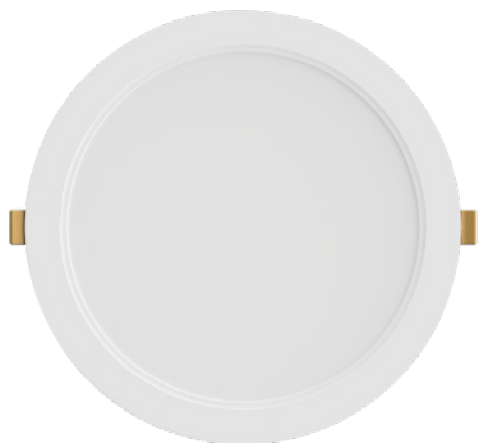

06-1224-*



FR-061224
Marco para sobreponer

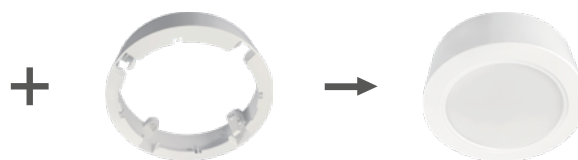

06-0718-*



FR-060718
Marco para sobreponer

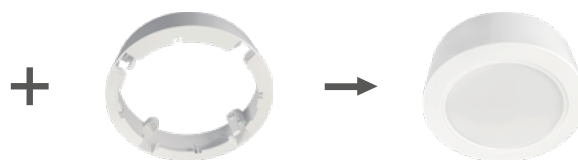

NOTA: Marcos para sobreponer se venden por separado.

Modelo	Watts	CT	Lúmens	Apertura	Voltaje	CRI	IP	Material
06-1224-*	24W	4100K	2400lm	90°	100-240V	>80	20	PC
06-0718-*	18W	3000K / 4100K	1800lm	90°	100-240V	>80	20	PC



06-0512-*

FR-060512
Marco para sobreponer



06-0409-*

FR-060409
Marco para sobreponer

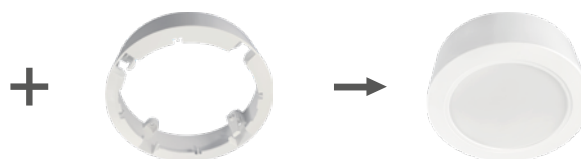

06-0305-*

NOTA: Macos para sobreponer se venden por separado.

Modelo	Watts	CT	Lúmens	Apertura	Voltaje	CRI	IP	Material
06-0512-*	12W	3000K / 4100K	1200lm	90°	100-240V	>80	20	PC
06-0409-*	9W	3000K / 4100K	900lm	90°	100-240V	>80	20	PC
06-0305-*	5W	3000K / 4100K	500lm	90°	100-240V	>80	20	PC

DOWNLIGHTS

LEO



06-0321-*

-01 Blanco -07 Negro



06-0322-*

-01 Blanco -07 Negro



06-0323-*

-01 Blanco -07 Negro



06-0325-*

-01 Blanco -07 Negro

NOTA: Soquet incluido. Foco se vende por separado.

Modelo	Base	Foco	Watts	Voltaje	IP	Material
06-0321-*	GU10	MR16	Máx.12W	127V	20	PC
06-0322-*	GU10	MR16	Máx.12W	127V	20	PC
06-0323-*	GU10	MR16	Máx.12W	127V	20	PC
06-0325-*	GU10	MR16	Máx.12W	127V	20	PC

LEO

DOWNLIGHTS

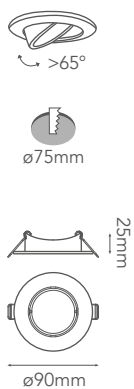

06-0326-*

-01 Blanco -07 Negro

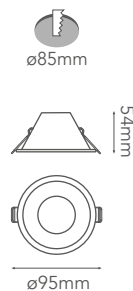

06-0329-*

-01 Blanco -07 Negro

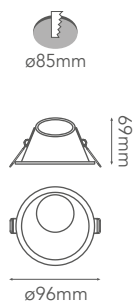

06-3210-*

-01 Blanco -07 Negro

NOTA: Soquet incluido. Foco se vende por separado.

Modelo	Base	Foco	Watts	Voltaje	IP	Material
06-0326-*	GU10	MR16	Máx. 12W	127V	20	PC
06-0329-*	GU10	MR16	Máx. 12W	127V	20	PC
06-3210-*	GU10	MR16	Máx. 12W	127V	20	PC

DOWNLIGHTS

LEO



-01 Blanco -07 Negro

06-3211-*

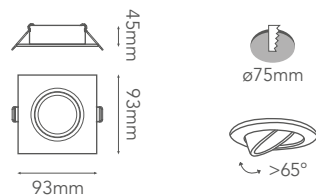

-01 Blanco -07 Negro

06-3212-*

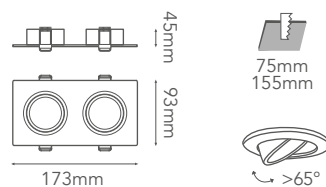

-01 Blanco -07 Negro

06-3213-*

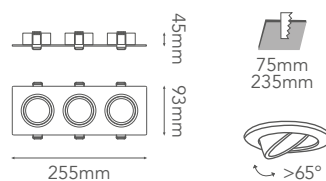

NOTA: Soquet incluido. Foco se vende por separado.

Modelo	Base	Foco	Watts	Voltaje	IP	Material
06-3211-*	GU10	MR16	Máx.12W	127V	20	PC
06-3212-*	GU10	MR16	Máx.12W	127V	20	PC
06-3213-*	GU10	MR16	Máx.12W	127V	20	PC

- Luminarios empotrables de aluminio, acabados Blanco y Negro.
- Piezas intercambiables (modular).
- Ángulos ajustables.
- Puede usarse con foco de bulbo MR16, base GU10 o Módulos LED dimeables de 7W y 12W.



DOWNLIGHTS

NOX



06-2901-*

-01 Blanco -07 Negro

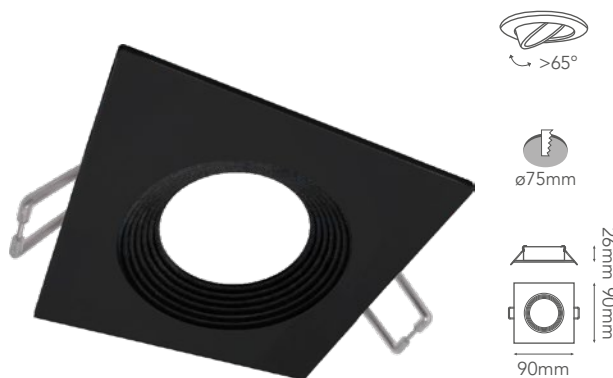

06-2904-*

-01 Blanco -07 Negro



06-2905-*

-01 Blanco -07 Negro



06-2906-*

-01 Blanco -07 Negro

*NOTA: Soquet y demás accesorios se venden por separado.

Modelo	Fuente Luminosa (Accesorios*)	IP	Material
06-2901-*	Foco de Bulbo MR16, Base GU10 / Módulo dimeable de LED 7W ó 12W	20	Aluminio
06-2904-*	Foco de Bulbo MR16, Base GU10 / Módulo dimeable de LED 7W ó 12W	20	Aluminio
06-2905-*	Foco de Bulbo MR16, Base GU10 / Módulo dimeable de LED 7W ó 12W	20	Aluminio
06-2906-*	Foco de Bulbo MR16, Base GU10 / Módulo dimeable de LED 7W ó 12W	20	Aluminio



06-2907-*

-01 Blanco -07 Negro



06-2910-*

-01 Blanco -07 Negro



06-2911-*

-01 Blanco -07 Negro

*NOTA: Soquet y demás accesorios se venden por separado.

Modelo	Fuente Luminosa (Accesorios*)	IP	Material
06-2907-*	Foco de Bulbo MR16, Base GU10 / Módulo dimeable de LED 7W ó 12W	20	Aluminio
06-2910-*	Foco de Bulbo MR16, Base GU10 / Módulo dimeable de LED 7W ó 12W	20	Aluminio
06-2911-*	Foco de Bulbo MR16, Base GU10 / Módulo dimeable de LED 7W ó 12W	20	Aluminio

DOWNLIGHTS

NOX



-01 Blanco -07 Negro

06-3901-*

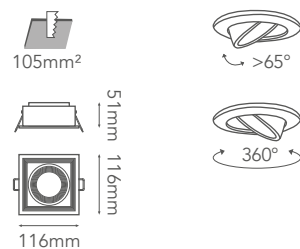

-01 Blanco -07 Negro

06-3902-*

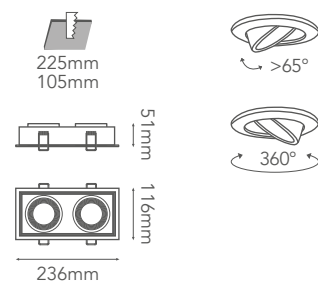

-01 Blanco -07 Negro

06-3903-*

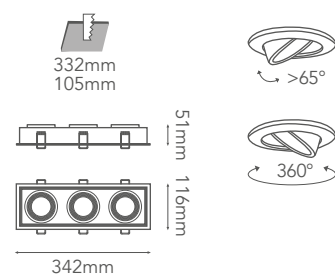

***NOTA:** Soquet y demás accesorios se venden por separado.

Modelo	Fuente Luminosa (Accesorios*)	IP	Material
06-3901-*	Foco de Bulbo MR16, Base GU10 / Módulo dimeable de LED 7W ó 12W	20	Aluminio
06-3902-*	Foco de Bulbo MR16, Base GU10 / Módulo dimeable de LED 7W ó 12W	20	Aluminio
06-3903-*	Foco de Bulbo MR16, Base GU10 / Módulo dimeable de LED 7W ó 12W	20	Aluminio

Opción 1: Foco + Soquet



Downlight
serie NOX

+



ARO-2912
Includo

+



Foco MR16
Se vende por separado

+



SQT-GU10
Se vende por separado

NOTA: Retirar ARO-2912 si va a usar Módulo LED.

Opción 2: Módulos de LED 7W ó 12W Dimeables

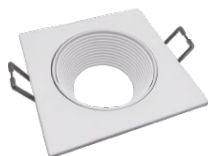

Downlight
serie NOX

+



Módulos de LED 7W ó 12W
Se vende por separado

Modelo	Watts	CT	Lúmenes	Apertura	Voltaje	CRI	IP	Material	
6-29007-*	7W	3000K	560	36°	110V	>80	20	Aluminio	
	7W	4000K	560	36°	110V	>80	20	Aluminio	
6-29012-*	12W	3000K	960	36°	110V	>80	20	Aluminio	
	12W	4000K	960	36°	110V	>80	20	Aluminio	

Sugerencia de uso



06-2906-01 + Módulo LED



06-2907-01 + Módulo LED



06-2910-01 + Módulo LED

PROFESIONAL



VULCANO

PROFESIONAL

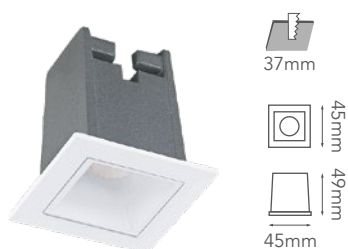

06-7091-*

-01 Blanco -07 Negro



06-7092-*

-01 Blanco -07 Negro

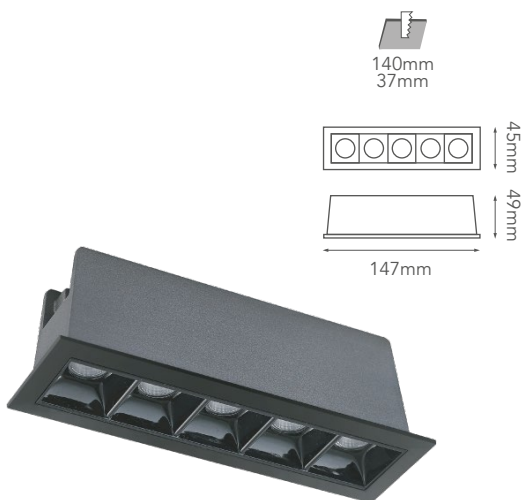

06-7095-*

-01 Blanco -07 Negro

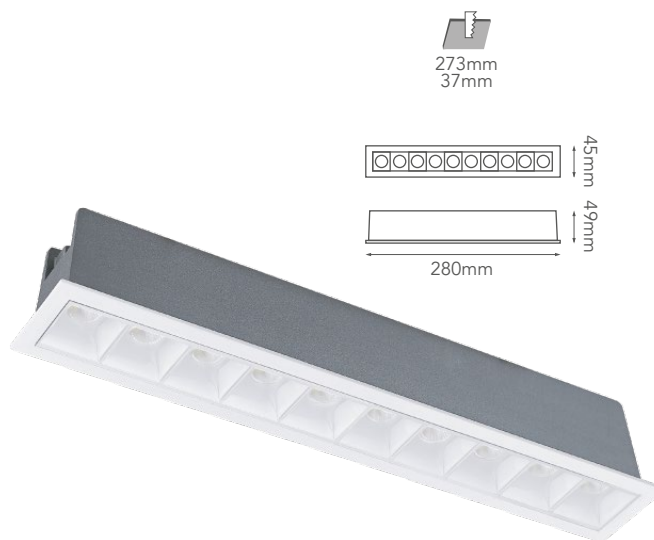



06-7010-*

-01 Blanco -07 Negro

Modelo	Watts	CT	Lúmenes	LED	Apertura	Voltaje	CRI	IP	Material
06-7091-*	2W	3000K	160	OSRAM	30°	100-265V	90	20	Aluminio
06-7092-*	4W	3000K	320	OSRAM	30°	100-265V	90	20	Aluminio
06-7095-*	10W	3000K	800	OSRAM	30°	100-265V	90	20	Aluminio
06-7010-*	20W	3000K	1600	OSRAM	30°	100-265V	90	20	Aluminio

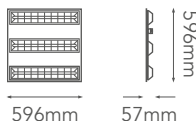
GRID PANEL LED PANEL



26-2601-* | 26-2601-40D 

-40 (4000K)
-50 (5000K)

ACCESORIOS:

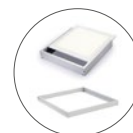

FR-2626
Marco para
sobreponer



CBL-3983
Cables para
suspender

*Se venden por separado.

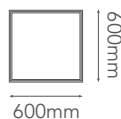

28-6640-50

*Para suspender.
Aluminio 6063 (No se dobla)

ACCESORIO:



CBL-6640

*Cable de acero
para suspender incluido.

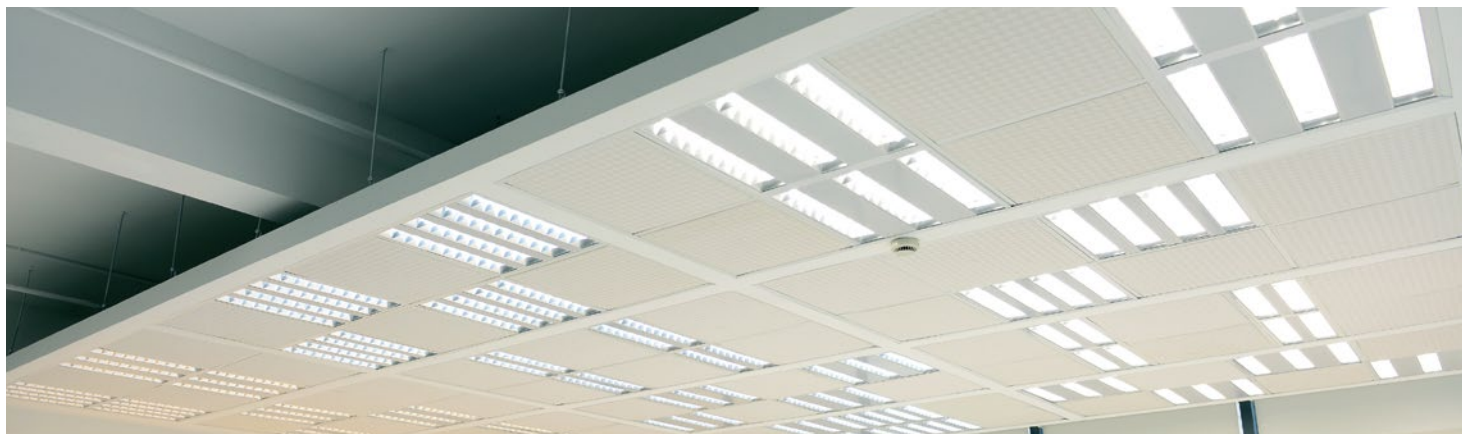

NOTA: Driver incluido.

Modelo	Watts	CT	Lúmenes	LED	Apertura	Voltaje	CRI	IP	Material
26-2601-*	30W	4000K / 5000K	2300	SMD	30°	100-277V / 110V	>80	20	Aluminio + Acero 
28-6640-50	40W	5000K	3600	SMD	120°	90-240V	>80	20	Aluminio 6063 + PMMA

BACKLITE PANEL

PROFESIONAL

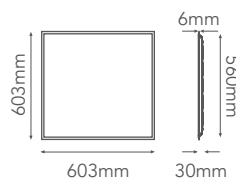

26-6640-40 | 26-6640-50

-01 Blanco

*Para empotrar

ACCESORIOS:

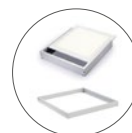

FR-2626-01
Marco para
sobreponer



CBL-6640
Cables para
suspender

*Se venden por separado.

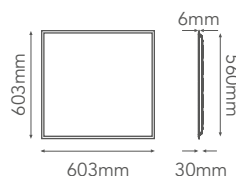
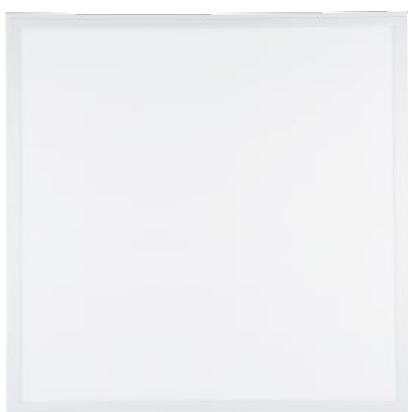

26-6640-CCT

-01 Blanco

*Para empotrar.

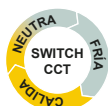

ACCESORIOS:

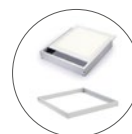

FR-2626-01
Marco para
sobreponer



CBL-6640
Cables para
suspender

*Se venden por separado.

NOTA: Driver incluido. Accesorios se venden por separado.

Modelo	Watts	CT	Lúmenes	LED	Voltaje	CRI	PF	IP	Material
26-6640-*	40W	4000K / 5000K	3600	SMD	110-240V	>80	0.9	20	Aluminio

NOTA: Driver incluido. Accesorios se venden por separado.

Modelo	Watts	CCT	Lúmenes	LED	Voltaje	CRI	PF	IP	Material
26-6640-CCT	40W	3000K / 4100K / 5000K	~4000	SMD	110-240V	>80	0.9	20	Aluminio

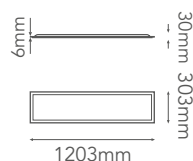
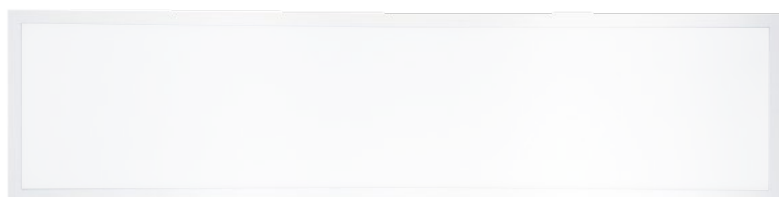

26-1340-40 | 26-1340-50

-01 Blanco

*Para empotrar.

ACCESORIOS:



FR-2613-01

Marco para
sobreponer



CBL-6640

Cables para
suspender

*Se venden por separado.

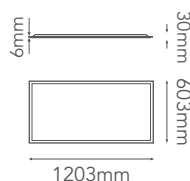

26-6675-50

-01 Blanco

*Para empotrar.

ACCESORIOS:

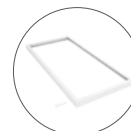

FR-12060

Marco para
sobreponer



CBL-6640

Cables para
suspender

*Se venden por separado.

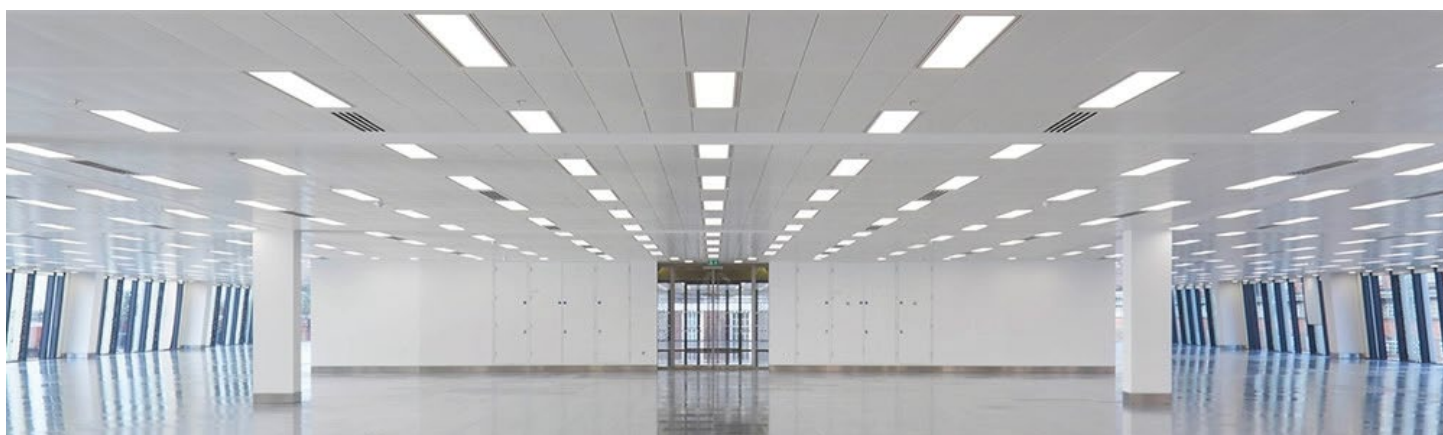

NOTA: Driver incluido. Accesorios se venden por separado.

Modelo	Watts	CT	Lúmenes	LED	Apertura	Voltaje	CRI	PF	IP	Material
26-1340-*	40W	4000K / 5000K	3600	SMD	120°	85-265V	>80	0.9	20	Aluminio 6063 + PMMA
26-6675-50	75W	5000K	6700	SMD	120°	85-265V	>80	0.9	20	Aluminio 6063 + PMMA

PROMETEO

PROFESIONAL

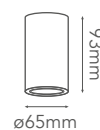

22-6503-*

-01 Blanco -07 Negro

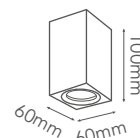

22-6504-*

-01 Blanco -07 Negro

NOTA: Foco se vende por separado.

Modelo	Base	Foco	Watts	Voltaje	IP	Material
22-6503-*	GU10	MR16	Máx.12W	100-240V	20	Aluminio
22-6504-*	GU10	MR16	Máx.12W	100-240V	20	Aluminio

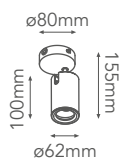

22-2409-*

-01 Blanco -07 Negro

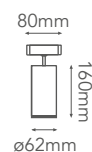
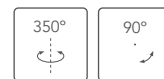

11-2409-*

-01 Blanco -07 Negro

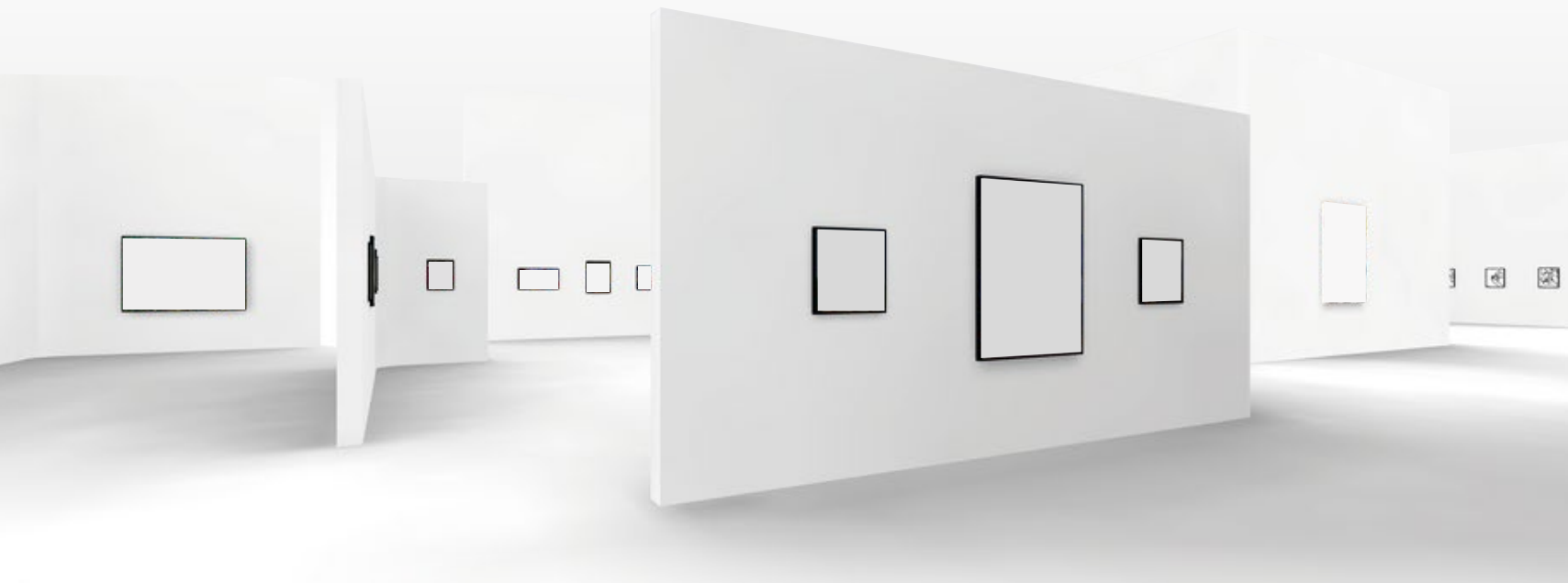

NOTA: Focos y Riel se venden por separado.

Modelo	Base	Foco	Watts	Voltaje	IP	Material
22-2409-*	GU10	MR16	Máx.12W	100-240V	20	Aluminio
11-2409-*	GU10	MR16	Máx.12W	100-240V	20	Aluminio



11-5009-*

-01 Blanco -07 Negro



11-2101-*

-01 Blanco -07 Negro



11-3001-*

-01 Blanco

NOTA: Driver incluido. Riel se vende por separado.

Modelo	Watts	CT	Lúmenes	LED	Apertura	Voltaje	CRI	IP	Material
11-5009-*	10W	3000K / 4500K	950	COB bridgelux .	24°	100-240V	>95	20	Aluminio
11-2101-*	21W	3000K / 4000K	1510	COB CREE	25°	100-240V	>80	20	Aluminio
11-3001-*	28W	3000K / 4000K	1830	COB CREE	24°	100-240V	>80	20	Aluminio



22-3002-*

-01 Blanco



Ángulo ajustable
10° a 60°

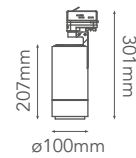
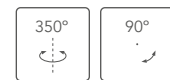

11-1735-*

-01 Blanco -07 Negro

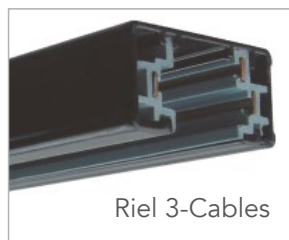

Riel 3-Cables

Nota: Todos nuestros luminarios a riel deben ser instalados usando un riel de 3 cables.

NOTA: Driver incluido. Riel se vende por separado.

Modelo	Watts	CT	Lúmenes	LED	Apertura	Voltaje	CRI	IP	Material
22-3002-*	28W	4000K	1830	COB CREE	24°	100-240V	>80	20	Aluminio
11-1735-*	35W	3000K / 5000K	3450	COB CITIZEN	Ajustable 10° a 60°	100-240V	>80	20	Aluminio

PANDORA

PROFESIONAL

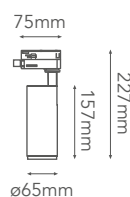
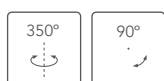

11-2815-*

-01 Blanco -07 Negro

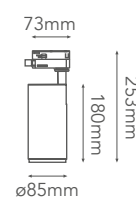
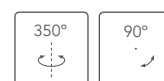

11-2825-*

-01 Blanco -07 Negro

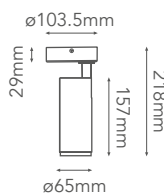
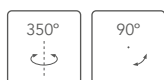

12-2815-*

-01 Blanco -07 Negro

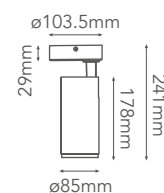
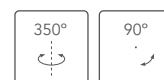

12-2825-*

-01 Blanco -07 Negro

NOTA: Lentes intercambiables, consultar ficha técnica.

Modelo	Watts	CT	Lúmenes	LED	Apertura	Voltaje	CRI	IP	Material
11-2815-*	15W	3000K / 5000K	1350	COB	24°	100-240V	>90	20	Aluminio
11-2825-*	25W	3000K / 5000K	2250	COB	24°	100-240V	>90	20	Aluminio
12-2815-*	15W	3000K	1350	COB	24°	100-240V	>90	20	Aluminio
12-2825-*	25W	3000K	2250	COB	24°	100-240V	>90	20	Aluminio

PROFESIONAL

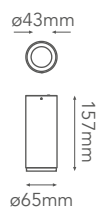

22-2815-*

-01 Blanco -07 Negro

PANDORA

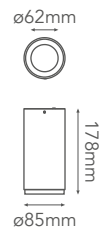

22-2825-*

-01 Blanco -07 Negro

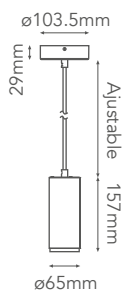

23-2815-*

-01 Blanco -07 Negro

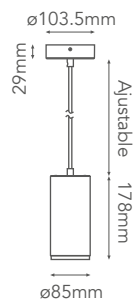

23-2825-*

-01 Blanco -07 Negro

NOTA: Lentes intercambiables, consultar ficha técnica.

Modelo	Watts	CT	Lúmenes	LED	Apertura	Voltaje	CRI	IP	Material
22-2815-*	15W	3000K	1350	COB	45°	100-240V	>90	20	Aluminio
22-2825-*	25W	3000K	2250	COB	60°	100-240V	>90	20	Aluminio
23-2815-*	15W	3000K	1350	COB	45°	100-240V	>90	20	Aluminio
23-2825-*	25W	3000K	2250	COB	60°	100-240V	>90	20	Aluminio

PANDORA

Riel de empotrar

PROFESIONAL

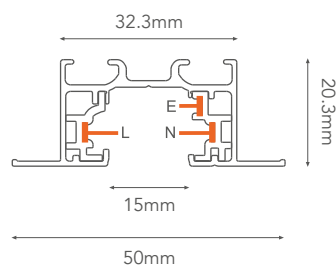
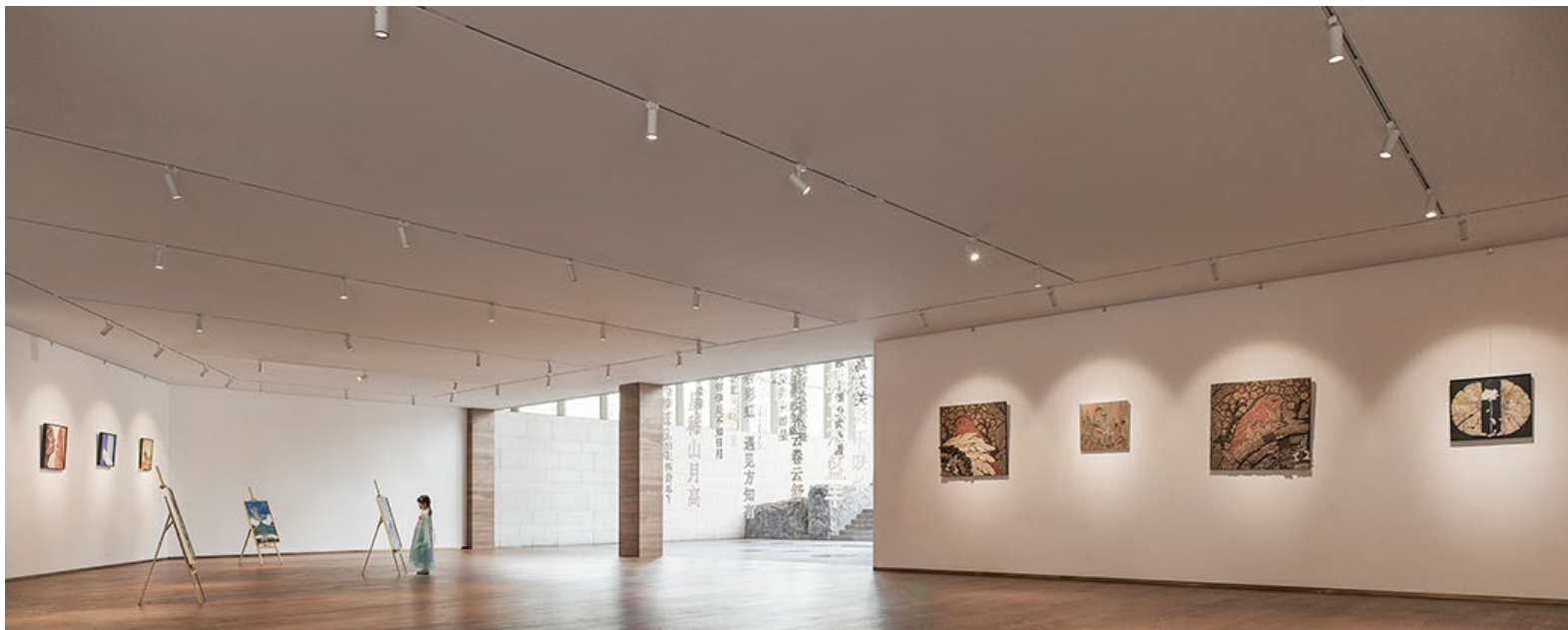

TR-0310-*

-01 Blanco -07 Negro

Longitud: 1m

TR-0320-*

-01 Blanco -07 Negro

Longitud: 2m

NOTA: Todos los rieles incluyen un Conector inicial y una Tapa final XR-366-*

Conectores para Riel de empotrar



XR-361L-*

Acometida
izquierda



XR-361R-*

Acometida
derecha



XR-363L-*

Conector en "L"
izquierda



XR-363R-*

Conector en "L"
derecha



XR-0362-*

Conector de continuidad



XR-0367-*

Conector de continuidad
interno



XR-0366-*

Tapa final



XR-0364LL-*

Conector en "T"
izquierda



XR-0364RL-*

Conector en "T"
izquierda



XR-0364RR-*

Conector en "T"
derecha



XR-0364LR-*

Conector en "T"
derecha



XR-0365-*

Conector en "X"



XR-369L-*

Conector ángulo ajustable
izquierda



XR-369R-*

Conector ángulo ajustable
derecha

REEL

Riel de sobreponer

PROFESIONAL

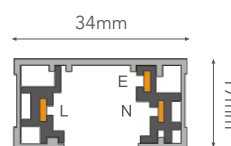

TRK-1000-*

-01 Blanco -07 Negro

Longitud: 1m

TRK-2000-*

-01 Blanco -07 Negro

Longitud: 2m

NOTA: Incluyen un Conector inicial y una Tapa final.

Conectores para Riel de sobreponer



CON-B2-*
Conector de continuidad
interno



CON-L3-*
Conector en "L"

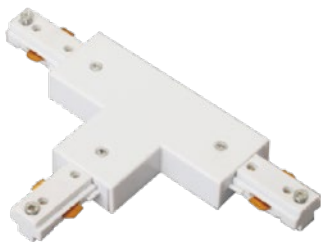

CON-T4-*
Conector en "T"

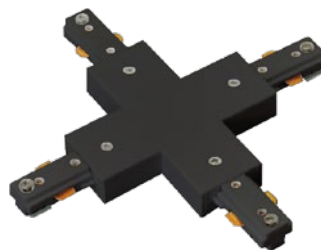
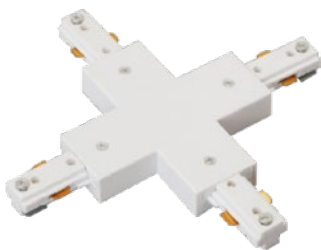

CON-X5-*
Conector en "X"



CON-F6-*
Conector flexible
ángulo ajustable

ALPHA LINE

PROFESIONAL

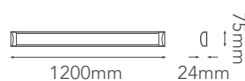

22-6136-DW

-01 Blanco

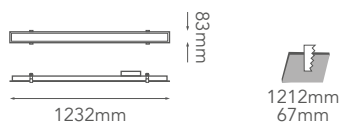

06-2011-*

-01 Blanco

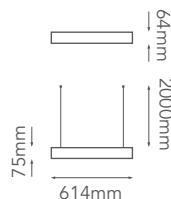

22-2060-WW

-03 Gris

ACCESORIO:



CON-2011

*Se vende por separado.

NOTA: Drivers y sistemas de fijación a techo incluidos.

Modelo	Watts	CT	Lúmenes	LED	Apertura	Voltaje	CRI	PF	IP	Material
22-6136-DW	36W	5000K	2880	SMD	120°	100-240V	>80	0.9	20	Aluminio + PC
06-2011-*	40W	3000K / 5000K	~3600	SMD	100°	100-240V	>80	0.9	20	Aluminio + PC
22-2060-WW	20W	3000K	1800	SMD	110°	100-240V	>80	-	20	Aluminio + PC

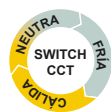

22-1232-*

-01 Blanco -07 Negro

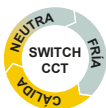
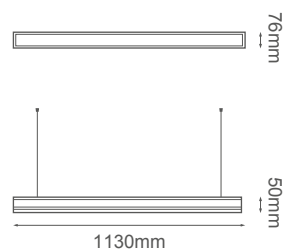

22-1216-*

-01 Blanco -07 Negro

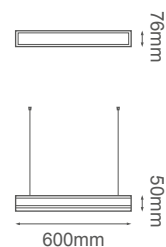

Accesorios para conectar varias piezas *Consultar ficha técnica

CON-221232-*

CONL-221232-*

CONT-221232-*

CBL-221232

Sugerencias de uso

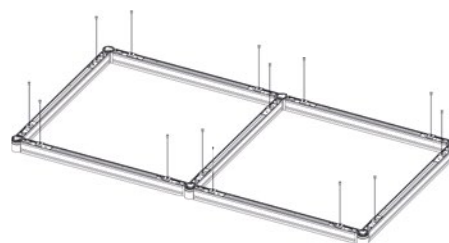

NOTA: Driver incluido. Accesorios se venden por separado.

Modelo	Watts	CCT	Lúmens	LED	Apertura	Voltaje	CRI	IP	Material
22-1232-*	32W	3000K / 4500K / 6000K	2580~3520	SMD	90°	100-240V	>80	20	Aluminio
22-1216-*	16W	3000K / 4500K / 6000K	1290~1760	SMD	90°	100-240V	>80	20	Aluminio

LINE

Conectores

PROFESIONAL



CON-221232

● Aluminio

Conector de continuidad interno.

Medidas: L100xW50xH30mm

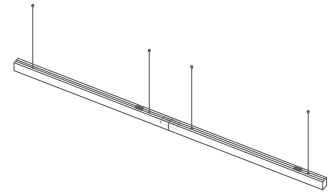

CONL-221232-*

● -01 Blanco ● -07 Negro

Conector de continuidad externo en "L"

Medidas: L50xW50xH73mm

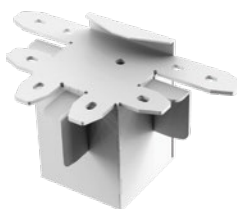
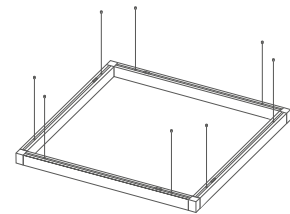

CONT-221232-*

● -01 Blanco ● -07 Negro

Conector de continuidad externo en "T"

Medidas: L50xW50xH73mm

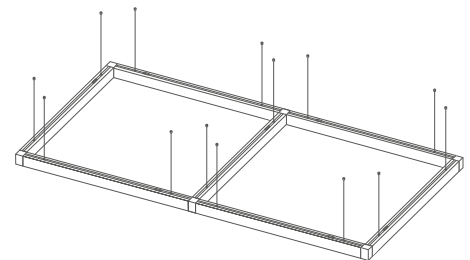

CORTESÍA



CONUS

CORTESÍA

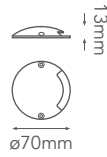

05-2801-* | 05-2807-*
(Kit 3 piezas)

-12 Aluminio

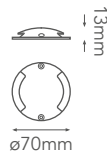

05-2800-* | 05-2806-*
(Kit 3 piezas)

-12 Aluminio

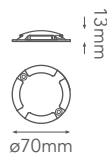

05-2799-* | 05-2805-*
(Kit 3 piezas)

-12 Aluminio

NOTA: Solo en KIT incluyen Transformador.

Modelo	Watts	CT	Lúmenes	LED	Voltaje	IP	Material
05-2801-* 05-2807-*	0.5W	3000K / 4000K / 5000K	20	5mm LED	12V CA/CD	67	Aluminio
05-2800-* 05-2806-*	0.8W	3000K / 4000K / 5000K	40	5mm LED	12V CA/CD	67	Aluminio
05-2799-* 05-2805-*	1W	3000K / 4000K / 5000K	60	5mm LED	12V CA/CD	67	Aluminio

CORTESÍA

KRAKEN

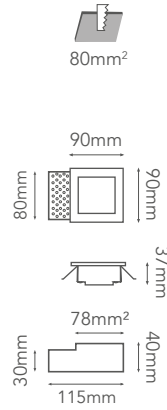

08-0360-*

-01 Blanco -02 Satinado

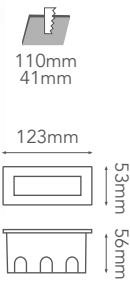

08-7501-*

-08 Acero

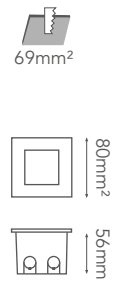

08-7401-*

-08 Acero

NOTA: Driver y Caja de Registro incluidos.

Modelo	Watts	CT	Lúmenes	LED	Voltaje	IP	Material
08-0360-*	3W	3000K	190	CREE SMD	127V	20	Aluminio + Cristal Templado
08-7501-*	1.5W	3000K	75	SMD	90-130V	65	Aluminio + SS316
08-7401-*	1.5W	3000K	75	SMD	90-130V	65	Aluminio + SS316

SIGN

CORTESÍA

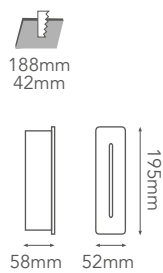

07-1276-*

-01 Blanco -03 Gris

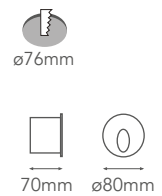

08-1273-*

-02 Satinado



Modelo	Watts	CT	Lúmenes	LED	Voltaje	IP	Material
08-1273-*	3W	3000K	160	SMD CREE	100-240V	54	Aluminio
07-1276-*	3W	3000K	160	SMD CREE	90-240V	54	Aluminio

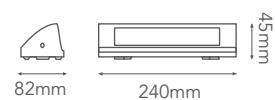

08-9002-*

-03 Gris -04 Grafito

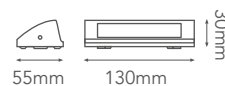
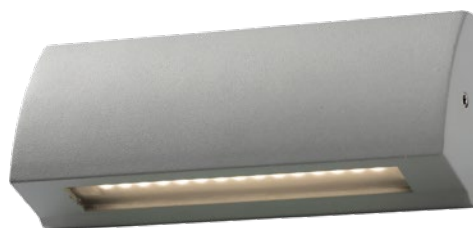

05-9001-*

-01 Blanco -03 Gris -04 Grafito

NOTA: Driver incluido.

Modelo	Watts	CT	Lúmenes	LED	Voltaje	IP	Material
08-9002-*	8W	3000K	530	SMD	90-130V	54	Aluminio + Cristal
05-9001-*	3.5W	3000K	170	SMD	90-240V	54	Aluminio + Cristal

SMART

CORTESÍA



08-9245-*

-01 Blanco -03 Gris -07 Negro

NOTA: Driver incluido.

Modelo	Watts	CT	Lúmenes	LED	Voltaje	IP	Material
08-9245-*	2.6W	3000K	200	SMD	100-240V	44	Aluminio

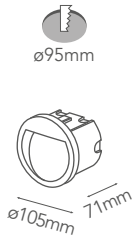

08-8301-*



-03 Gris -04 Grafito

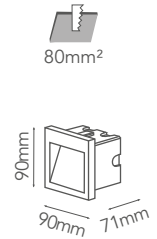

08-8401-*



-03 Gris -04 Grafito

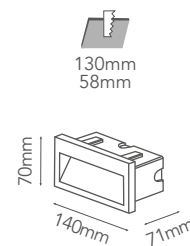

08-8501-*



-03 Gris -04 Grafito

NOTA: Driver incluido.

Modelo	Watts	CT	Lúmenes	LED	Voltaje	IP	Material	
08-8301-*	3W	3000K	105	SMD 2835	90-130V	54	Aluminio + Cristal	
08-8401-*	3W	3000K	105	SMD 2835	90-130V	54	Aluminio + Cristal	
08-8501-*	3W	3000K	105	SMD 2835	90-130V	54	Aluminio + Cristal	

KELPIE

CORTESÍA

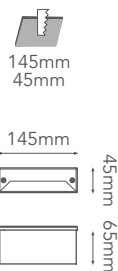

07-4201-*

-03 Gris

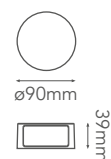
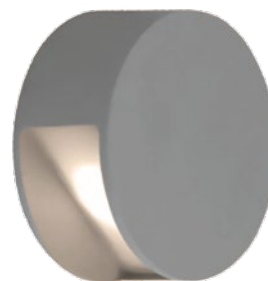

05-7001-*

-03 Gris

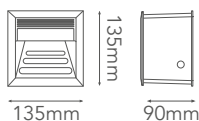

07-1280-*

-03 Gris

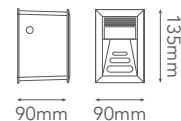

07-2702-*

-03 Gris

NOTA: Driver incluido.

Modelo	Watts	CT	Lúmenes	LED	Apertura	Voltaje	IP	Material
07-4201-*	1W	3000K	60	SMD	120°	110-240V	54	Aluminio + Cristal
05-7001-*	4W	3000K	320	SMD	90°	100-240V	44	Aluminio
07-1280-*	1.5W	3000K	90	SMD	-	127V	65	Aluminio
07-2702-*	1.2W	3000K	75	SMD	-	127V	65	Aluminio

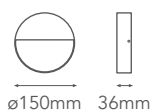

08-1901-*

-01 Blanco -04 Grafito

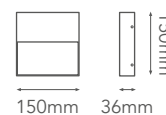

08-2201-*

-01 Blanco -04 Grafito

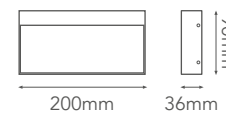

08-2203-*

-01 Blanco -04 Grafito

NOTA: Driver incluido.

Modelo	Watts	CT	Lúmenes	LED	Voltaje	CRI	IP	Material
08-1901-*	6W	3000K	140	SMD	100-240V	>80	54	Aluminio
08-2201-*	6W	3000K	140	SMD	100-240V	>80	54	Aluminio
08-2203-*	6W	3000K	140	SMD	100-240V	>80	54	Aluminio

OUTDOOR PARED



OUTDOOR PARED

ARIES

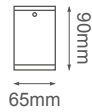

22-7161-*

"A Techo"

-01 Blanco -03 Gris -04 Grafito

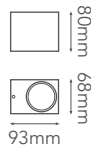

05-7493-*

-01 Blanco -03 Gris -04 Grafito

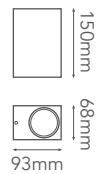

05-7494-*

-01 Blanco -03 Gris -04 Grafito

NOTA: Focos se venden por separado.

Modelo	Base	Foco	Watts	Voltaje	IP	Material
22-7161-*	GU10	MR16	Máx. 12W	127V	44	Aluminio + Cristal Templado
05-7493-*	GU10	MR16	Máx. 12W	127V	44	Aluminio + Cristal Templado
05-7494-*	GU10	MR16	Máx. 2x12W	127V	44	Aluminio + Cristal Templado

ODÍN

OUTDOOR PARED



22-9051-*

"A Techo"

-01 Blanco -03 Gris -04 Grafito

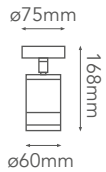

05-8054-*

-01 Blanco -03 Gris -04 Grafito

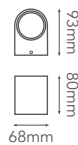

05-7491-*

-01 Blanco -03 Gris -04 Grafito

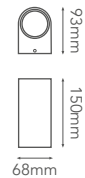

05-7492-*

-01 Blanco -03 Gris -04 Grafito

NOTA: Focos se venden por separado.

Modelo	Base	Foco	Watts	Voltaje	IP	Material
22-9051-*	GU10	MR16	Máx. 12W	130V	44	Aluminio + Cristal Templado
05-8054-*	GU10	MR16	Máx. 12W	130V	44	Aluminio + Cristal Templado
05-7491-*	GU10	MR16	Máx. 12W	130V	44	Aluminio + Cristal Templado
05-7492-*	GU10	MR16	Máx. 2x12W	130V	44	Aluminio + Cristal Templado

OUTDOOR PARED

ARIA



22-5031-*
"A Techo"

-03 Gris -04 Grafito

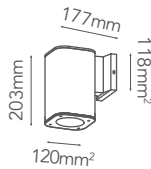

05-5031-*

-03 Gris -04 Grafito

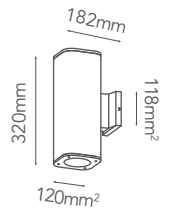

05-5032-*

-03 Gris -04 Grafito

NOTA: Focos se venden por separado.

Modelo	Base	Foco	Watts	Voltaje	IP	Material
22-5031-*	E27	PAR20	Máx.60W	120-240V	54	Aluminio + Cristal
05-5031-*	E26	PAR20	Máx.60W	120-240V	54	Aluminio + Cristal
05-5032-*	2*E26	2*PAR20	Máx. 2x60W	120-240V	54	Aluminio + Cristal

EOS

OUTDOOR PARED

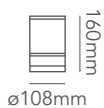

22-7133-*

"A Techo"

- 01 Blanco
- 03 Gris
- 04 Grafito

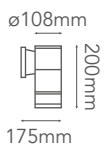

05-7131-*

- 01 Blanco
- 03 Gris
- 04 Grafito

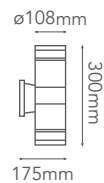

05-7132-*

- 01 Blanco
- 03 Gris
- 04 Grafito

NOTA: Focos se venden por separado.

Modelo	Base	Foco	Watts	Voltaje	IP	Material
22-7133-*	E26	A19 / PAR30	Máx. 60W	130V	44	Aluminio + Cristal Templado
05-7131-*	E26	A19 / PAR30	Máx. 60W	130V	44	Aluminio + Cristal Templado
05-7132-*	E26	A19 / PAR20	Máx. 2x60W	130V	44	Aluminio + Cristal Templado

OUTDOOR PARED

NIX | OMEGA

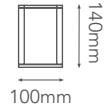

22-2073-*

"A Techo"

-03 Gris

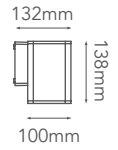

05-2071-*

-03 Gris

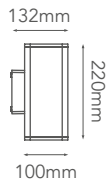

05-2072-*

-03 Gris

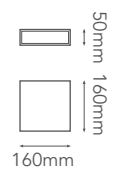

05-1018-*

-03 Gris -04 Grafito

Modelo	Watts	CT	Lúmenes	LED	Apertura	Voltaje	IP	Material
22-2073-*	12W	3000K	870	CREE COB	46°	100-240V	54	Aluminio
05-2071-*	12W	3000K	870	CREE COB	46°	100-240V	54	Aluminio
05-2072-*	2x12W	3000K	870	CREE COB	46°	100-240V	54	Aluminio
05-1018-*	2x8W	3000K	2x560	SMD 2835	-	127V	65	Aluminio + Cristal

OSIRIS | ZODIAC ANDRÓMEDA

OUTDOOR PARED

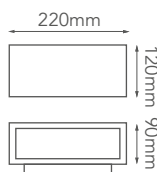

05-7302-*

-01 Blanco -04 Grafito

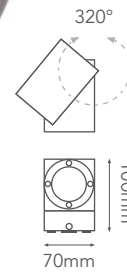

05-1016-*

-03 Gris -04 Grafito

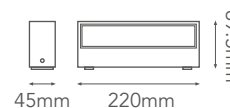

05-9801-*

-03 Gris -04 Grafito

NOTA: Del modelo 05-7302-* se vende el foco por separado.

Modelo	Watts	Base	CT	Lúmenes	LED	Apertura	Voltaje	IP	Material
05-7302-*	Máx. 18W	E26	-	-	-	-	130V	44	Aluminio
05-1016-*	7W	-	3000K	630	SMD CREE	90°	100-240V	54	Aluminio
05-9801-*	2x8W	-	3000K	2x490	SMD CREE	-	90-240V	54	Aluminio

OUTDOOR PARED

DIAMANTE ORIÓN



05-2509-*

-03 Gris

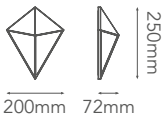

05-2701-*

-01 Blanco -04 Grafito

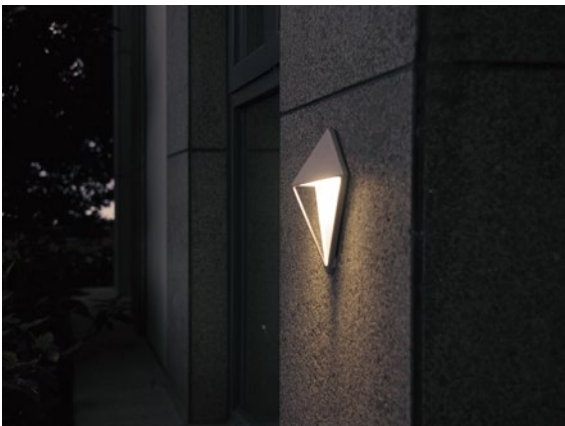
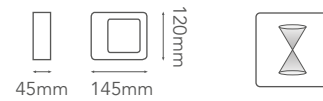

Modelo	Watts	CT	Lúmenes	LED	Apertura	Voltaje	IP	Material
05-2509-*	9W	3000K	400	SMD	-	90-130V	65	Aluminio
05-2701-*	7W	3000K	360	SMD CREE	92°	100-240V	54	Aluminio + PC

BOREAL

OUTDOOR PARED



05-1841-*

-01 Blanco -04 Grafito

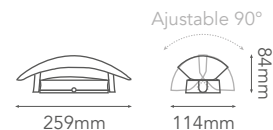

05-8107-*

-01 Blanco -04 Grafito

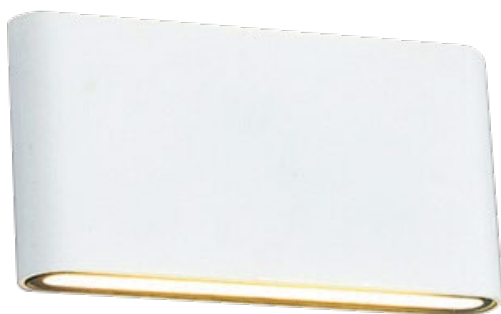
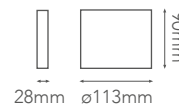

05-8108-*

-01 Blanco -04 Grafito

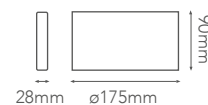

Modelo	Watts	CT	Lúmenes	LED	Apertura	Voltaje	IP	Material
05-1841-*	9W	3000K	810	SMD	155°	90-240V	54	Aluminio
05-8107-*	8W	3000K	640	SMD EPISTAR	-	90-240V	65	Aluminio +PC
05-8108-*	12W	3000K	960	SMD EPISTAR	-	90-240V	65	Aluminio +PC

OUTDOOR PARED

SURYA | BRIK



05-3223-*

-07 Negro

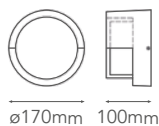

ø170mm 100mm



05-2616-*

-05 Bronce Rust

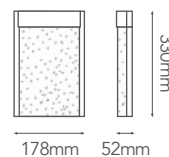

178mm 52mm

Modelo	Watts	CT	Lúmenes	LED	Voltaje	CRI	IP	Material
05-3223-*	8W	3000K	450	PCB	127V	>80	54	Aluminio + Acrílico
05-2616-05	9W	3000K	400	PCB	127V	>80	54	Aluminio + Cristal

URANO

OUTDOOR PARED

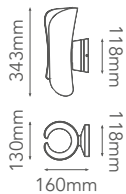

05-0093-*

-07 Negro

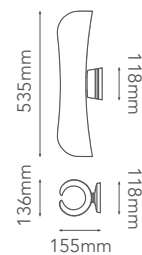

05-0094-*

-07 Negro

Modelo	Base	Foco	Watts	CT	LED	Lúmenes	Voltaje	IP	Material
05-0093-*	2*GU10	2*MR16	Máx. 2*12W	-	-	-	110-240V	54	Aluminio
05-0094-*	-	-	2*11W	3000K	SMD 2835	1980	120V	54	Aluminio

OUTDOOR PARED

CRETA

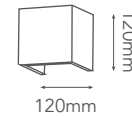

05-7510-*

-11 Concreto



Modelo	Watts	CT	Lúmenes	LED	Voltaje	CRI	IP	Material
05-7510-*	10W	3000K	900	PHILIPS	110-277V	>80	54	Concreto + Alum

OUTDOOR PISO



OUTDOOR PISO

CRETA MINI TERRA

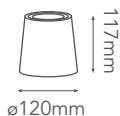

07-7053-*

-11 Concreto

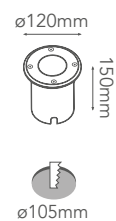

07-9201-*

-08 Acero



NOTA: Foco se vende por separado.

Modelo	Base	Foco	Watts	Voltaje	IP	Material
07-7053-*	GU10	MR16	Máx.12W	110-240V	65	Concreto + Cristal
07-9201-*	GU10	MR16	Máx.12W	127V	65	Tapa de SS316

NINFA

OUTDOOR PISO

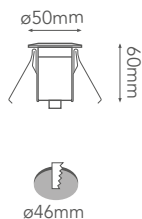

07-1701-*

-02 Satinado

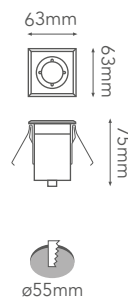

07-1703-*

-02 Satinado

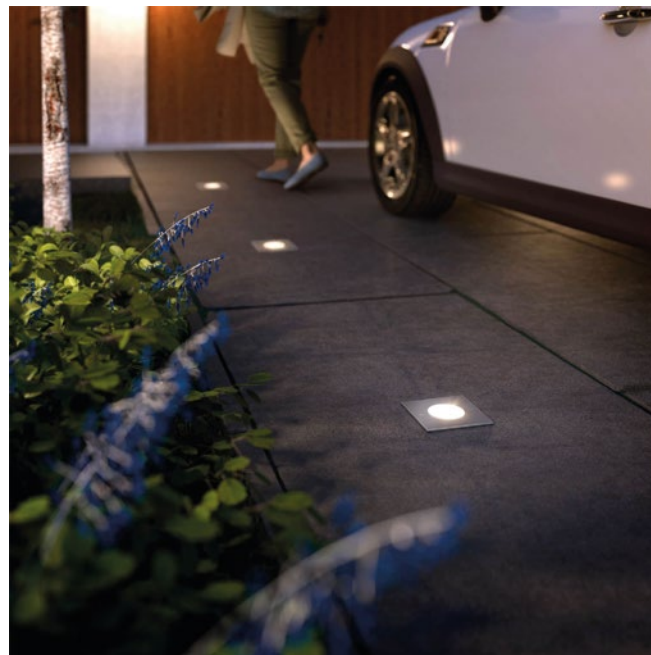

Modelo	Watts	CT	Lúmenes	LED	Apertura	Voltaje	CRI	IP	Material
07-1701-*	.5W	3000K / 4000K / 5000K	30	5mm LED	45°	127V	>80	67	Aluminio + Cristal
07-1703-*	.5W	3000K	30	5mm LED	58°	127V	>80	67	Aluminio + Cristal

OUTDOOR PISO

OCTOPUS SMOOTH



07-0061-*

Soporta paso vehicular de hasta 2 toneladas.

-03 Gris



07-0062-*

Soporta paso vehicular de hasta 2 toneladas.

-03 Gris

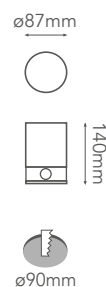

07-2721-*

*Housing Acero

Modelo	Watts	CT	Lúmenes	LED	Apertura	Voltaje	IP	Material
07-0061-*	2.4W	3000K / 4000K	65	CREE SMD	-	24V DC	65	Tapa de SS316
07-0062-*	2.4W	3000K / 4000K	192	CREE SMD	-	24V DC	65	Tapa de SS316
07-2721-*	3W	3000K / 4000K	180	CREE SMD	120°	220-240V AC	67	Alum + Cristal Templ.

OCTOPUS II

OUTDOOR PISO

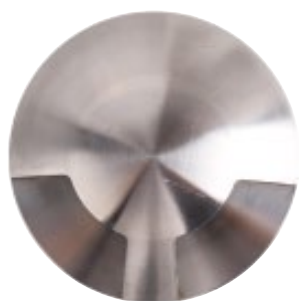

07-40921-*

Ø8 Acero

07-40922-*

Ø8 Acero

07-40926-*

Ø8 Acero



Modelo	Watts	CT	Lúmenes	LED	Voltaje	CRI	IP	Material
07-40921-*	3W	3000K	270	SMD EPISTAR	100-240V	>80	67	Acero SS316
07-40922-*	3W	3000K	300	SMD EPISTAR	100-240V	>80	67	Acero SS316
07-40926-*	3W	3000K	330	SMD EPISTAR	100-240V	>80	67	Acero SS316

OUTDOOR PISO

BUNKER



07-30011-*

07-30012-*

07-30016-*

-03 Gris

-03 Gris

-03 Gris

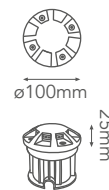

Modelo	Watts	CT	Lúmenes	LED	Voltaje	CRI	IP	Material
07-30011-*	3W	3000K	270	SMD	100-240V	>80	67	Aluminio
07-30012-*	3W	3000K	300	SMD	100-240V	>80	67	Aluminio
07-30016-*	3W	3000K	330	SMD	100-240V	>80	67	Aluminio

TERRA | TERRA II

OUTDOOR PISO



07-0301-*

-08 Acero



07-30100-*

-08 Acero

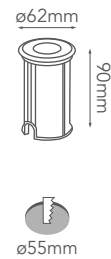

07-62100-*

-08 Acero

Modelo	Watts	CT	Lúmenes	LED	Apertura	Voltaje	IP	Material
07-0301-*	3W	3000K / 4000K	300	SMD CREE	45°	100-240V	65	Tapa de SS316
07-30100-*	3W	3000K	177	SMD bridgelux	45°	100-240V	67	Tapa de SS316
07-62100-*	1W	3000K	62	SMD bridgelux	45°	100-240V	67	Tapa de SS316

OUTDOOR PISO

ATLANTIC



ø120mm



07-6201-*

-08 Acero



ø140mm

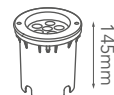

07-6301-*

-08 Acero

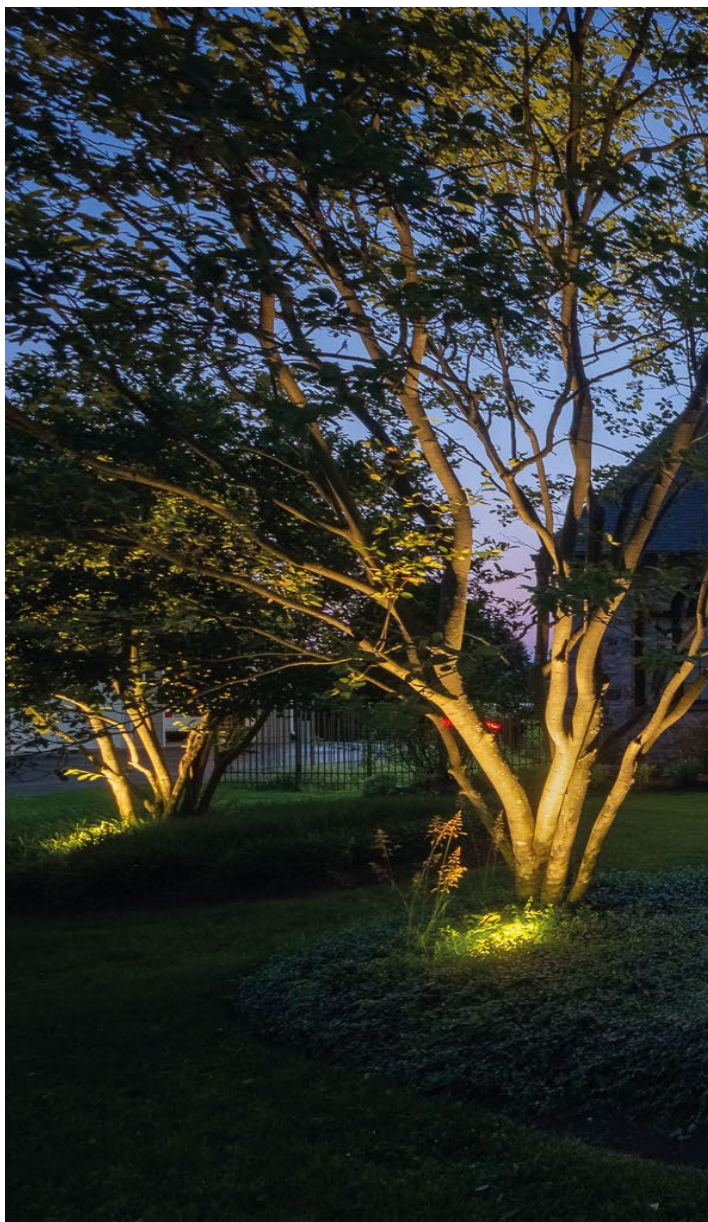

Modelo	Watts	CT	Lúmenes	LED	Apertura	Voltaje	CRI	IP	IK	Material
07-6201-10-*	9W	3000K	850	CREE SMD	20°	100-240V	>80	67	10	Tapa de SS316
	9W	4000K	900	CREE SMD	20°	100-240V	>80	67	10	Tapa de SS316
07-6201-*	9W	3000K	850	CREE SMD	45°	100-240V	>80	67	10	Tapa de SS316
	9W	4000K	900	CREE SMD	45°	100-240V	>80	67	10	Tapa de SS316
07-6301-10-*	12W	3000K	1083	CREE SMD	20°	100-240V	>80	67	10	Tapa de SS316
	12W	4000K	1140	CREE SMD	20°	100-240V	>80	67	10	Tapa de SS316
07-6301-*	12W	3000K	1083	CREE SMD	45°	100-240V	>80	67	10	Tapa de SS316
	12W	4000K	1140	CREE SMD	45°	100-240V	>80	67	10	Tapa de SS316

ATLANTIC

OUTDOOR PISO



07-6401-*

-08 Acero



ø180mm



174mm



ø141mm



07-7301-*

-08 Acero



ø250mm



190mm



ø202mm

Modelo	Watts	CT	Lúmenes	LED	Apertura	Voltaje	CRI	IP	IK	Material
07-6401-10-*	18W	3000K	1625	CREE SMD	20°	100-240V	>80	67	10	Tapa de SS316
	18W	4000K	1710	CREE SMD	20°	100-240V	>80	67	10	Tapa de SS316
07-6401-*	18W	3000K	1625	CREE SMD	45°	100-240V	>80	67	10	Tapa de SS316
	18W	4000K	1710	CREE SMD	45°	100-240V	>80	67	10	Tapa de SS316

Modelo	Watts	CT	Lúmenes	LED	Apertura	Voltaje	CRI	IP	IK	Material
07-7301-*	36W	3000K / 4000K	3600	CREE SMD	20° / 45°	100-240V	>80	67	10	Tapa de SS316

OUTDOOR PISO

GEA



07-07300-*

-08 Acero

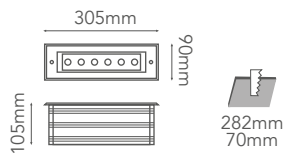

97-06300-*

-08 Acero

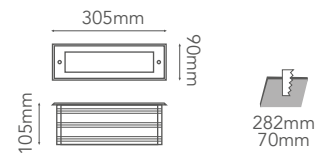

07-07601-*

-08 Acero

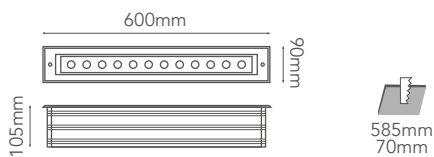

97-06601-*

-08 Acero

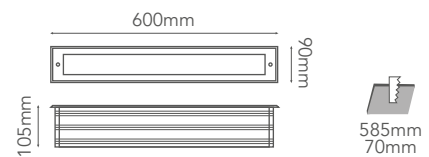

Modelo	Watts	CT	Lúmenes	LED	Apertura	Voltaje	IP	Material
07-07300-*	6W	3000K	600	SMD <i>bridgelux</i>	45°	100-240V	67	Aluminio + SS316
97-06300-*	6W	3000K	600	SMD <i>bridgelux</i>	120°	100-240V	67	Aluminio + SS316
07-07601-*	12W	3000K	1200	SMD <i>bridgelux</i>	45°	100-240V	67	Aluminio + SS316
97-06601-*	12W	3000K	1200	SMD <i>bridgelux</i>	120°	100-240V	67	Aluminio + SS316

SPIKE LIGHTS

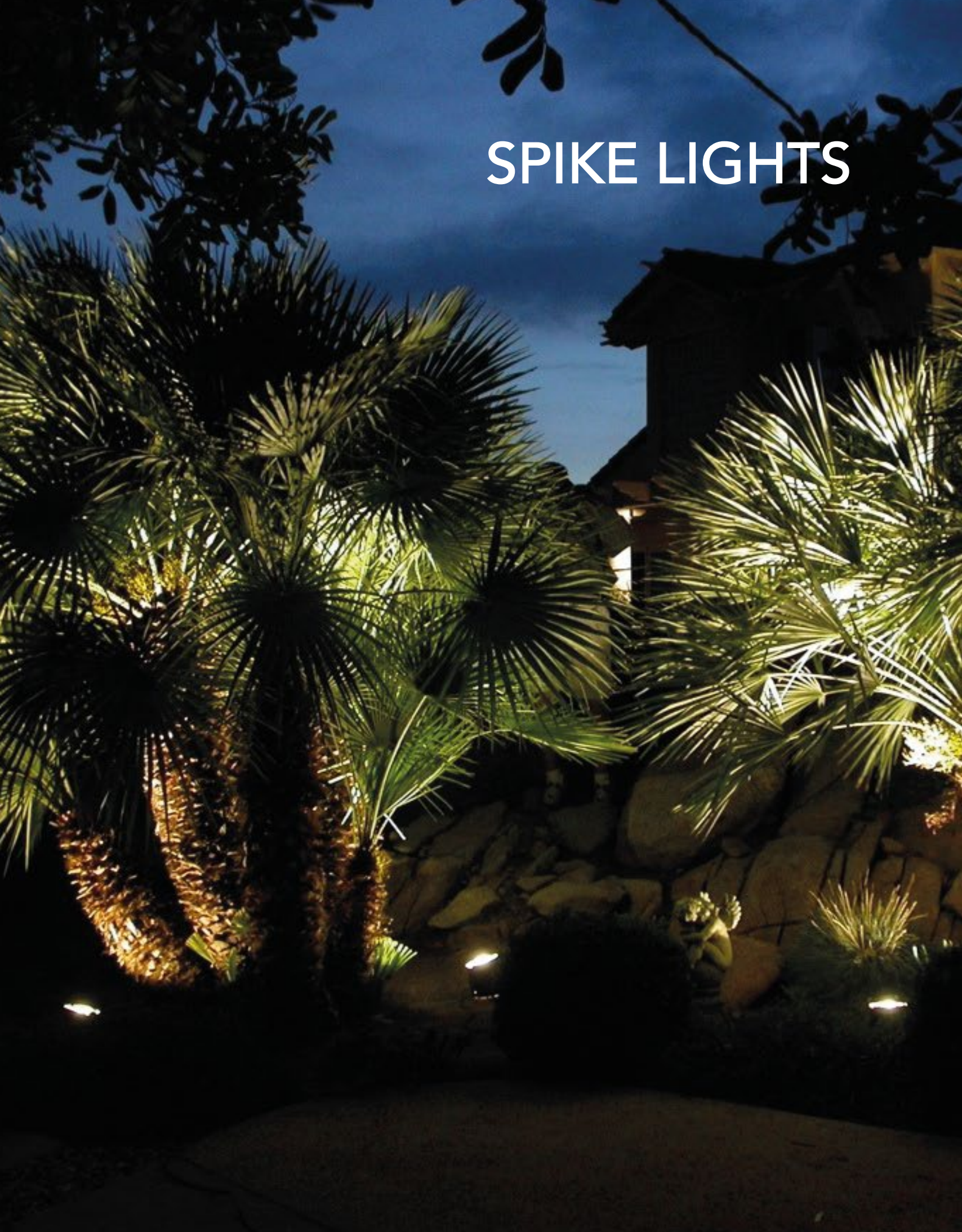

SPIKE LIGHTS

DIANA ONDINA MINI

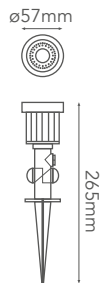

05-3505-CW

-07 Negro

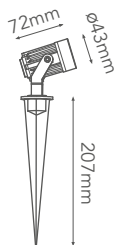

05-9105-*

-07 Negro

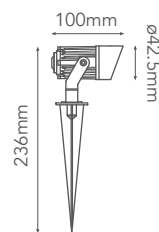

05-9205-*

-07 Negro

NOTA: Driver y estaca incluidos.

Modelo	Watts	CT	Lúmenes	LED	Apertura	Voltaje	CRI	IP	Material
05-3505-CW	5W	6500K	400	SMD	38°	100-240V	>80	65	Plástico
05-9105-*	5W	3000K / 4000K / 6000K	450	COB EPISTAR	30°	90-130V	>80	65	Aluminio
05-9205-*	5W	3000K / 6000K	450	COB EPISTAR	30°	90-130V	>80	65	Aluminio

ONDINA

SPIKE LIGHTS

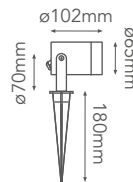

03-4801-*

-04 Grafito

*Foco se vende por separado



CAP-05-9106

*Se vende por separado

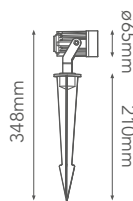

05-9106-*

-04 Grafito

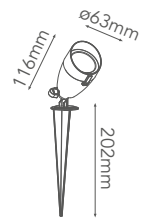

03-4901-*

-04 Grafito

NOTA: Driver y estaca incluidos.

Modelo	Watts	Base	Foco	CT	Lúmenes	LED	Apertura	Voltaje	CRI	IP	Material
03-4801-*	Máx. 12W	GU10	MR16	-	-	-	-	127V	-	65	Alum + Cristal
05-9106-*	10W	-	-	3000K / 4000K	800	bridgeLED COB	38°	100-240V AC	>80	65	Alum + Cristal
03-4901-*	6W	-	-	3000K / 4000K	420	SMD	45°	100-130VAC	>80	65	Alum + Acrílico

SUBACUÁTICAS



HYDRA II

SUBACUÁTICAS



77-2501-*

-08 Acero

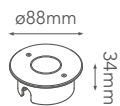

77-2503-*

-08 Acero

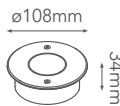

77-2506-*

-08 Acero

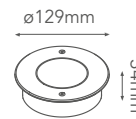

NOTA: Requieren transformador 24VCD. Además deben trabajar siempre sumergidos en agua.

Modelo	Watts	CT	Lúmenes	LED	Apertura	Voltaje	CRI	IP	Material
77-2501-*	3.9W	3000K / 5000K	165	CREE XP	12.5°	24V DC	>80	68	SS316
77-2503-*	8.3W	3000K / 5000K	420	CREE XP	12.6°	24V DC	>80	68	SS316
77-2506-*	14.3W	3000K / 5000K	793	CREE XP	12.9°	24V DC	>80	68	SS316

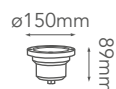

Housing
incluido



77-4703-*

-08 Acero

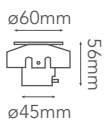

ø45mm



07-1707-*

-02 Satinado

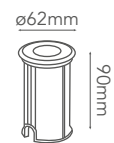

ø62mm



07-62024-*

-08 Acero

NOTA: Requieren transformador. Además deben trabajar siempre sumergidos en agua.

Modelo	Watts	CT	Lúmenes	LED	Apertura	Voltaje	CRI	IP	Material	
77-4703-*	12W	3000K / 4000K / 5000K	960	SMD	15°	24V CD	>80	68	SS316	
07-1707-*	1W	3000K	62	SMD <i>bridgelux</i>	45°	12V CD/CA	>80	68	Aluminio	
07-62024-*	1W	3000K	62	SMD <i>bridgelux</i>	45°	24V CD	>80	68	Aluminio + SS316	

HYDROX | SQUID AQUA

SUBACUÁTICAS

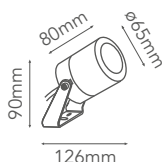

07-4051-*

-08 Acero

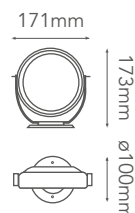

05-7021-*

-03 Gris

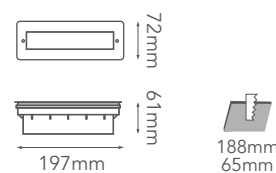

07-0455-*

*Incluye Transformador 12V.

-08 Acero

NOTA: Requieren transformador. Además deben trabajar siempre sumergidos en agua.

Modelo	Watts	CT	Lúmenes	LED	Apertura	Voltaje	CRI	IP	Material
07-4051-*	7W	3000K / 4000K	630	SMD	30°	24V CD	>80	68	Acero SS316
05-7021-*	30W	4000K	2700	SMD	15°	24V CD	>80	68	Acero SS316
07-0455-*	3.2W	3000K / 4000K	156	SMD CREE	-	127 / 12V	>80	68	Acero SS316

SUBACUÁTICAS

DELTA

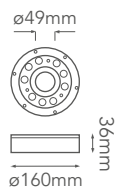

77-0391-*

-08 Acero

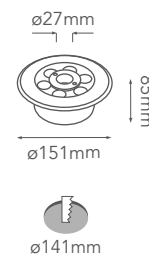

77-0306-DW

-08 Acero

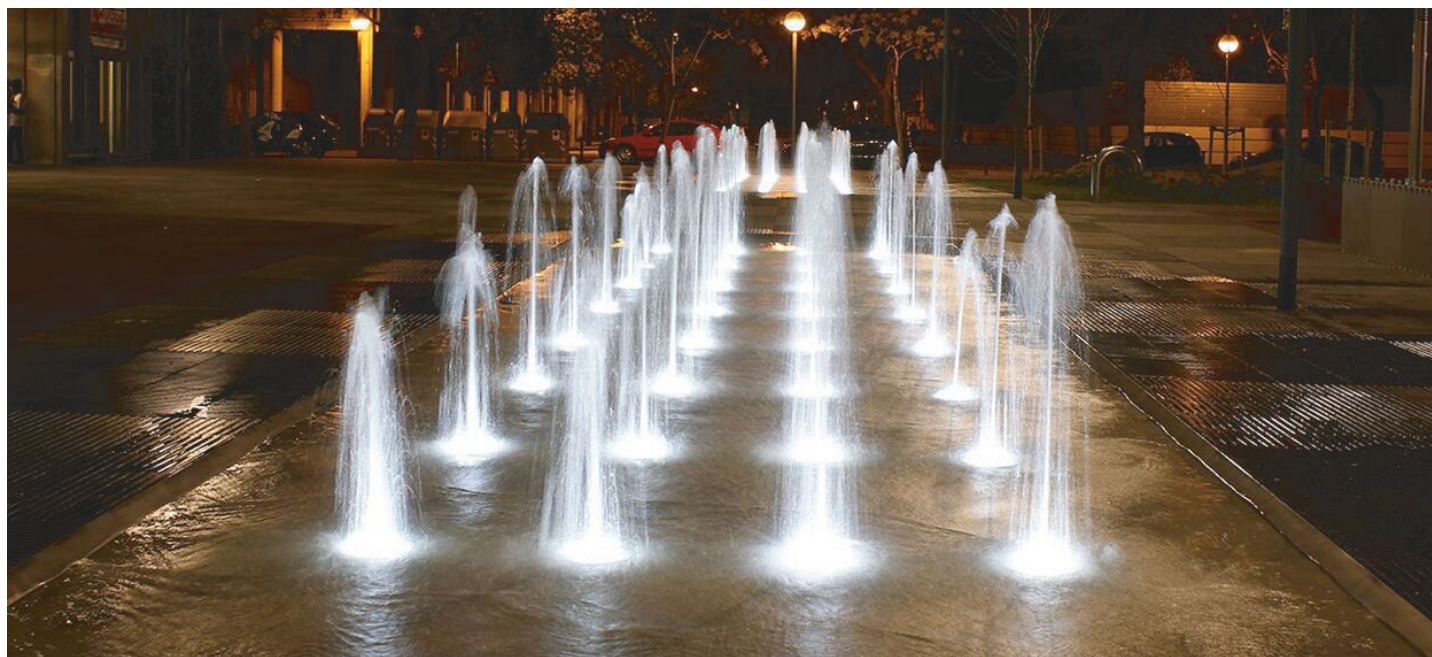

NOTA: Requieren transformador 24VCD. Además deben trabajar siempre sumergidos en agua.

Modelo	Watts	CT	Lúmenes	LED	Apertura	Voltaje	CRI	IP	Material
77-0391-*	13.5W	3000K / 5000K	720	SMD CREE	45°	24V CD	>80	68	Acero SS316
77-0306-DW	6W	5000K	420	SMD bridgelux	45°	24V CD	>80	68	Acero SS304

BALIZAS



BALIZAS

CAGE

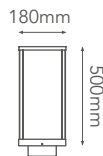

10-1932-*

-05 Bronze Rust

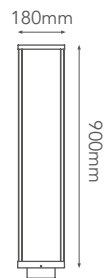

55-1933-*

-05 Bronze Rust

Modelo	Watts	CT	Lúmenes	LED	Apertura	Voltaje	CRI	IP	Material
10-1932-*	12W	3000K	700	SMD CREE	125°	100-240V	>80	54	Aluminio
55-1933-*	12W	3000K	700	SMD CREE	125°	100-240V	>80	54	Aluminio

VENUS | ORION

BALIZAS

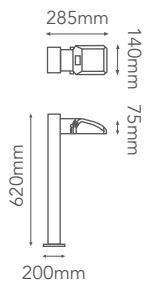

55-2301-*

-03 Gris

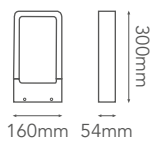

10-2704-*

-04 Grafito

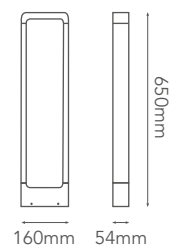

55-2704-*

-04 Grafito

Modelo	Watts	CT	Lúmenes	LED	Apertura	Voltaje	CRI	IP	Material
55-2301-03	16W	4000K	1460	SMD	100°	110-240V	>80	65	Aluminio
10-2704-04	7W	3000K	560	SMD <i>bridgelux</i>	-	100-240V	>80	IP55 / Driver IP65	Aluminio
55-2704-04	5W	3000K	360	SMD <i>bridgelux</i>	-	100-240V	>80	IP55 / Driver IP65	Aluminio

BALIZAS

PHARO

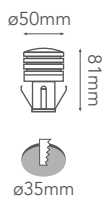

10-1071-*

-03 Gris

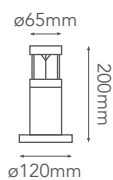

10-9107-*

-03 Gris



55-9107-*

-03 Gris

Modelo	Watts	CT	Lúmenes	LED	Voltaje	CRI	IP	Material
10-1071-*	1W	3000K / 6000K	60	SMD CREE	100-240V	>80	67	Aluminio
10-9107-*	3W	3000K	330	SMD CREE	100-240V	>80	54	Aluminio
55-9107-*	3W	4000K	330	SMD CREE	100-240V	>80	54	Aluminio

POLARIS

BALIZAS

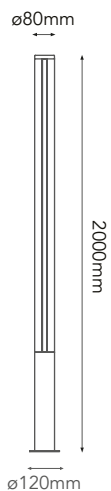

55-2091-WW

-04 Grafito

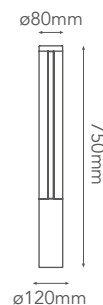

10-2091-WW

-04 Grafito

Modelo	Watts	CT	Lúmenes	LED	Apertura	Voltaje	CRI	IP	Material
55-2091-WW	27W	3000K	1290	SMD	112°	100-240V	>80	IP55 / Driver IP65	Aluminio
10-2091-WW	9W	3000K	500	SMD	112°	100-240V	>80	IP55 / Driver IP65	Aluminio



55-2773-*

-04 Grafito

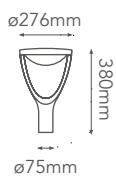

55-2775-*

-04 Grafito



Modelo	Watts	CT	Lúmenes	LED	Apertura	Voltaje	IP	Material
55-2773-*	22W	3000K	1850	SMD 2835	144°	100-240V	65	Aluminio + PC
55-2775-*	22W	3000K	1850	SMD 2835	144°	100-240V	65	Aluminio + PC

REFLECTORES

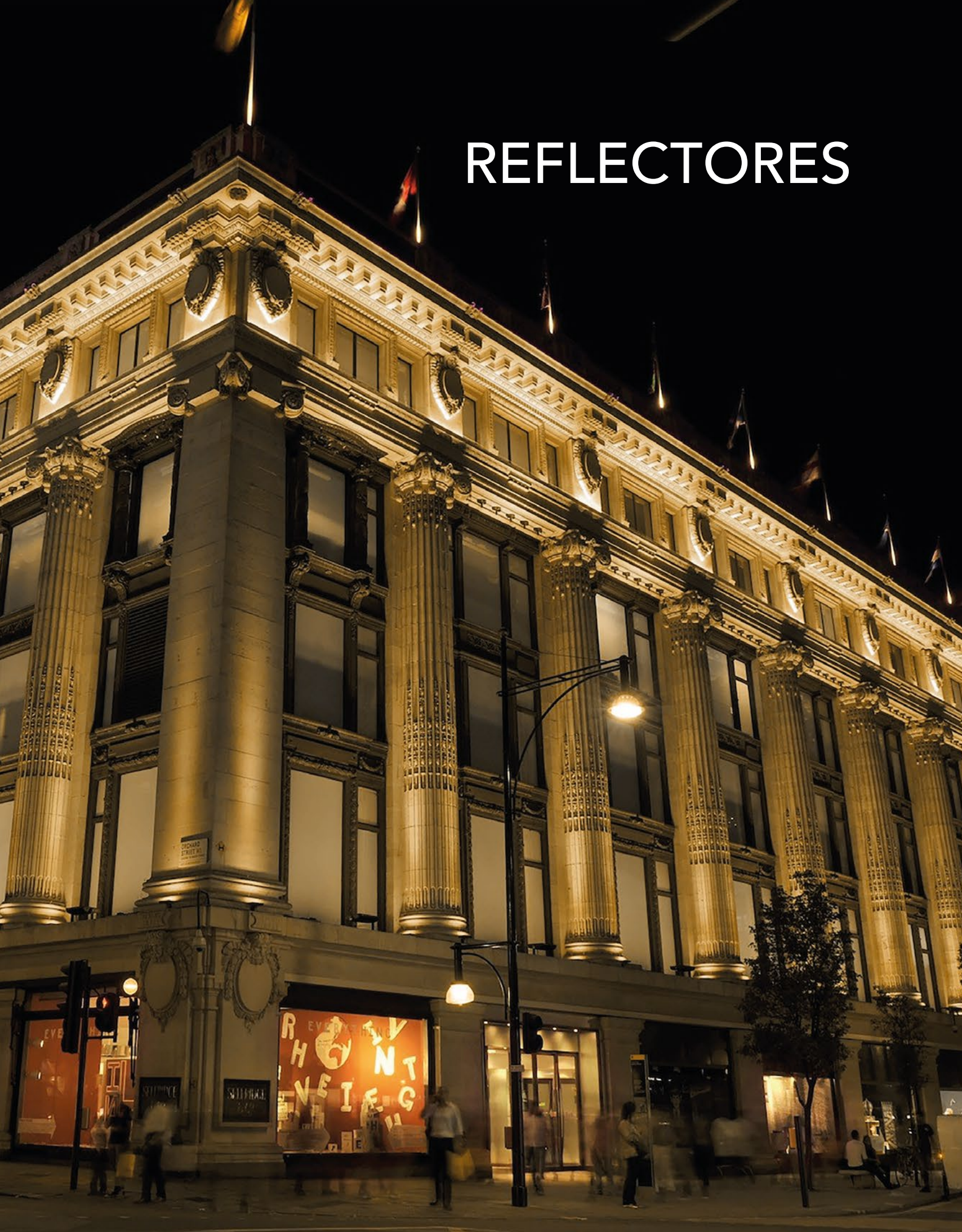



90-3001-*

-03 Gris

*Requiere Fuente de Poder.

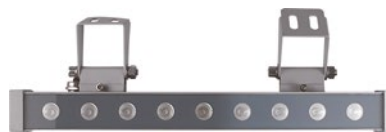
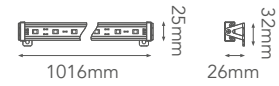

90-3201-WW

-03 Gris

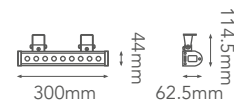

90-3202-*

-03 Gris

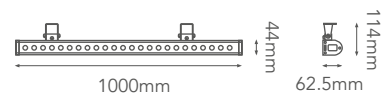

Modelo	Watts	CT	LED	Lúmenes	Apertura	Voltaje	CRI	IP	Material
90-3001-*	11.5W	3000K / 4000K	SMD	700	120°	24V CD	>80	67	Aluminio
90-3201-WW	9W	3000K	SMD	900	25°x45°	100-240V	>80	65	Aluminio + Cristal Templado
90-3202-*	24W	3000K / 4000K	SMD CREE	2100	45°	100-240V	>80	65	Aluminio + Cristal Templado

LUMI-THOR

REFLECTORES



05-0010-*

-07 Negro



109mm 27mm



76mm



05-0020-*

-07 Negro



128mm 27mm



84mm



05-0030-*

-07 Negro



155mm 27mm



105mm

NOTA: Driver incluido, 50cm de Cable.

Modelo	Watts	CT	Lúmenes	LED	Apertura	Voltaje	CRI	PF	IP	Material
05-0010-*	10W	3000K / 6000K	800	SMD	120°	90-260V	>80	0.9	65	Aluminio
05-0020-*	20W	3000K / 6000K	1600	SMD	120°	85-265V	>80	0.9	65	Aluminio
05-0030-*	30W	3000K / 6000K	2400	SMD	120°	85-265V	>80	0.9	65	Aluminio

REFLECTORES

LUMI-THOR



05-0050-*

-07 Negro

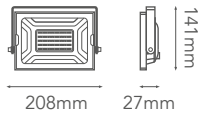

5-25100-*

-07 Negro

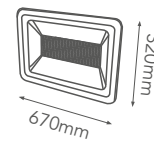
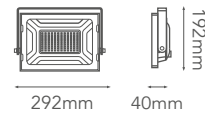

5-25400-WW

NOTA: Driver incluido, 50cm de Cable.

Modelo	Watts	CT	Lúmenes	LED	Apertura	Voltaje	CRI	PF	IP	Material
05-0050-*	50W	3000K / 5000K	4000	SMD	120°	85-265V	>80	0.9	65	Aluminio
5-25100-*	100W	3000K / 5000K	8000	SMD	120°	110-130V	>80	0.9	65	Aluminio
5-25400-WW	400W	3000K	30000	SMD	120°	85-265V	>80	0.9	65	Aluminio



5-25250-DW

-07 Negro

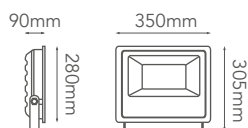

05-3500-DW

-07 Negro

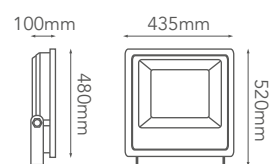

Modelo	Watts	CT	Lúmenes	LED	Apertura	Voltaje	CRI	PF	IP	Material
5-25250-DW	250W	5000K	20000	SMD	120°	85-265V	>80	0.9	65	Aluminio + Cristal
05-3500-DW	500W	5000K	45000	SMD	120°	85-265V	>80	0.9	65	Aluminio + Cristal



5-21101-NW

-03 Gris

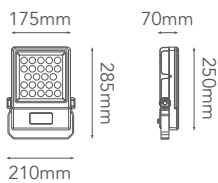

5-21201-NW

-03 Gris

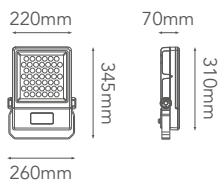

5-21301-NW

-03 Gris

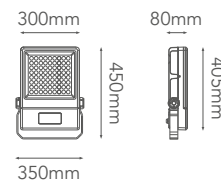

Modelo	Watts	CT	Lúmenes	LED	Apertura	Voltaje	CRI	IP	Material
5-21101-NW	50W	4100K	6000	SMD 3737	30°	100-240V AC	>80	65	Aluminio
5-21201-NW	100W	4100K	12000	SMD 3737	30°	100-240V AC	>80	65	Aluminio
5-21301-NW	150W	4100K	18000	SMD 3737	30°	100-240V AC	>80	65	Aluminio

SISTEMAS RGB



SISTEMAS RGB

SKY | NINFA ONDINA | TERRA



6-26752-RGB

-01 Blanco



07-1701-RGB

-02 Satinado



05-0901-RGB

*Estaca se vende por separado



07-0301-RGB

-08 Acero

NOTA: Controlador y Fuente de Poder se venden por separado.

Modelo	Watts	CT	LED	Apertura	Voltaje	IP	Material
6-26752-RGB	9W	RGB	COB	38°	12V CD	20	Aluminio
07-1701-RGB	1.5W	RGB	SMD	45°	12V CD	68	Aluminio + SS316
05-0901-RGB	3W	RGB	SMD CREE	45°	12V CD	67	Aluminio
07-0301-RGB	6W	RGB	SMD CREE	45°	12V CD	67	Tapa de SS316

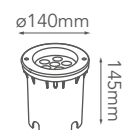

07-6301-RGB

-08 Acero

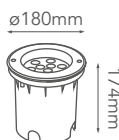

07-6401-RGB

-08 Acero

NOTA: Controlador y Fuente de Poder se venden por separado.

Modelo	Watts	CT	LED	Apertura	Voltaje	IP	IK	Material
07-6301-RGB	12W	RGB	SMD 3737	45°	12V CD	67	10	Tapa de SS316
07-6401-RGB	18W	RGB	SMD 3737	45°	12V CD	10	67	Tapa de SS316



77-6013-RGB



-08 Acero

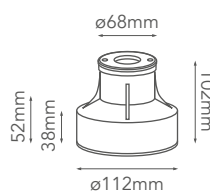

77-6015-RGB



-08 Acero

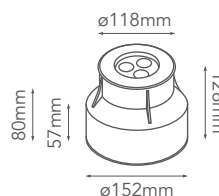

NOTA: Controlador y Fuente de Poder se venden por separado.

Modelo	Watts	CT	LED	Apertura	Voltaje	IP	Material
77-6013-RGB	3W	RGB	CREE SMD	60°	24V DC	68	Tapa de SS316
77-6015-RGB	5W	RGB	CREE SMD	60°	24V DC	68	Tapa de SS316

DELTA | HYDRA SQUID

SISTEMAS RGB

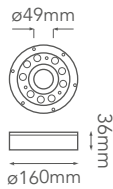

77-0393-RGB

-08 Acero



77-4703-RGB

-08 Acero

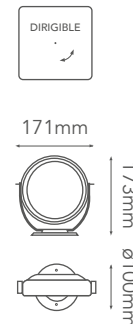

05-7021-RGB

-03 Gris

NOTA: Requieren Controlador y Fuente de Poder.

Modelo	Watts	CT	LED	Apertura	Voltaje	CRI	IP	Material
77-0393-RGB	31.5W	RGB	CREE SMD	45°	24V CD	>80	68	SS316
77-4703-RGB	17W	RGB	CREE SMD	15°	24V CD	>80	68	SS316
05-7021-RGB	30W	RGB	CREE SMD	15°	24V CD	>80	68	SS316



55-4021-RGBW

-04 Grafito



Modelo	Watts	CT	LED	Voltaje	IP	Material
55-4021-RGBW	15W	RGBW	SMD 2835	127V	65	Aluminio



05-0502-RGB

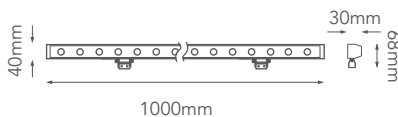
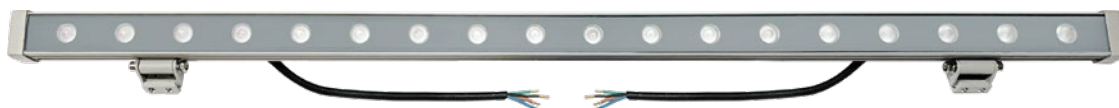

90-2501-RGB

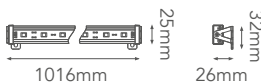

90-3001-RGB

NOTA: Controlador y Fuente de Poder se venden por separado.

Modelo	Watts	CT	LED	Apertura	Voltaje	CRI	IP	Material
05-0502-RGB	20W	RGB	CREE SMD	45°x25°	24V CD	>80	65	Aluminio
90-2501-RGB	32W	RGB	CREE SMD	45°	24V CD	>80	65	Aluminio
90-3001-RGB	11.5W	RGB	CREE SMD	120°	24V CD	>80	67	Aluminio



5-21101-RGB

-03 Gris

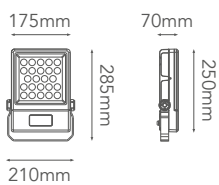

5-21201-RGB

-03 Gris

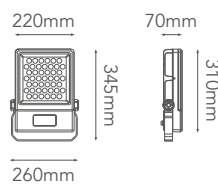

5-21301-RGB

-03 Gris

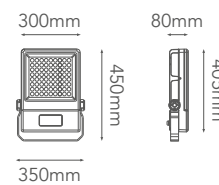

NOTA: Controlador se vende por separado.

Modelo	Watts	CT	LED	Apertura	Voltaje	CRI	IP	Material
5-21101-RGB	50W	RGB	SMD 3737	30°	100-240V AC	>80	65	Aluminio
5-21201-RGB	100W	RGB	SMD 3737	30°	100-240V AC	>80	65	Aluminio
5-21301-RGB	150W	RGB	SMD 3737	30°	100-240V AC	>80	65	Aluminio

INDUSTRIAL

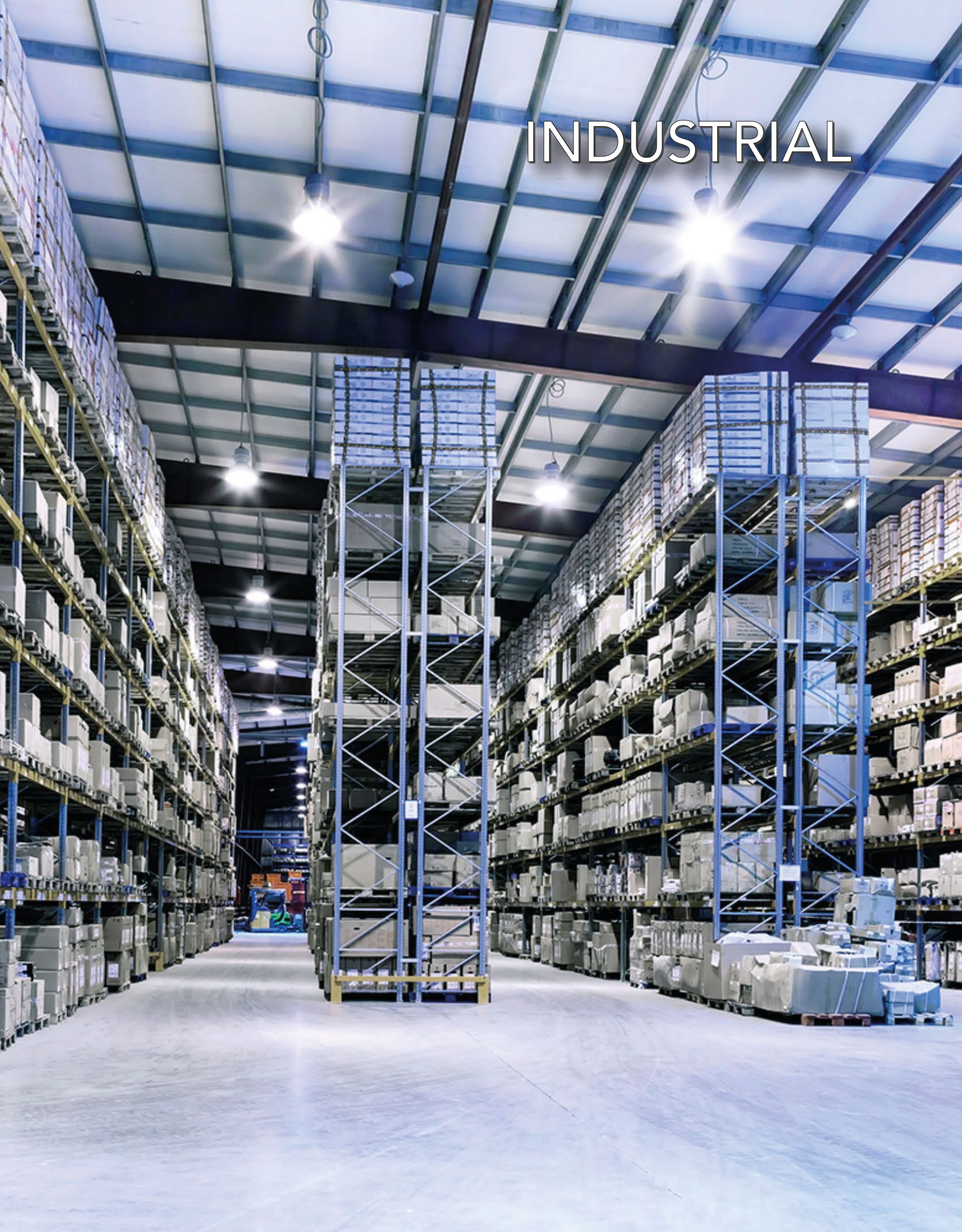

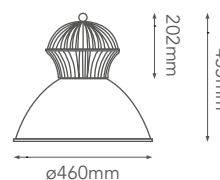

20-9080-40/65

-03 Gris

Modelo	Watts	CT	Lúmenes	LED	Apertura	Voltaje	CRI	IP	Material
20-9080-40	80W	4000K	7500	EPISTAR COB	90°	85-265V	>80	65	Aluminio
20-9080-65	80W	6000K	7500	EPISTAR COB	90°	85-265V	>80	65	Aluminio

HIBAY | UFO

INDUSTRIAL

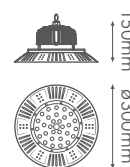

20-3110-50

-07 Negro

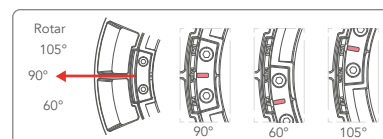
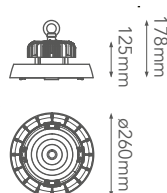

20-7100-50

-07 Negro

Lente ajustable patentado para lograr cambios de 60°, 90° y 105°

Modelo	Watts	CT	LED	Lúmenes	Apertura	Voltaje	CRI	IP	Material
20-3110-50	100W	5000K	SMD	10000	180°	110-240V	>80	65	Aluminio + PC
20-7100-50	100W	5000K	SMD	13000	60°, 90°, 105°	100-277V	>80	65	Aluminio + PC

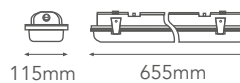

22-0210-*

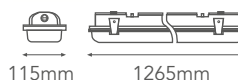

22-0218-*

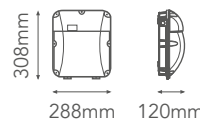

27-4001-40

*Fotocelda se vende por separado

Modelo	Watts	CT	Lúmenes	LED	Apertura	Voltaje	IP	Material
22-0210-*	20W	6000K	2000	SMD	180°	90-260V	65	Aluminio + PC
22-0218-*	36W	4000K / 6000K	3600	SMD	180°	90-260V	65	Aluminio + PC
27-4001-40	50W	4000K	4000	COB	120°	90-260V	65	Aluminio + PC

URBANA



URBANA



15-0050-65

-03 Gris

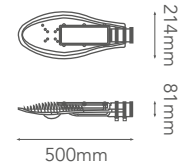

15-0100-65

-03 Gris

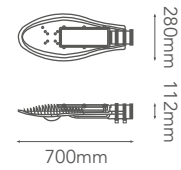

15-0150-65

-03 Gris

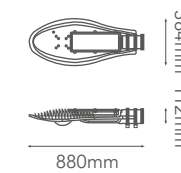

Modelo	Watts	CT	LED	Lúmenes	Apertura	Voltaje	IP	Material
15-0050-65	50W	6000K	COB <i>bridgelux.</i>	4500	80°x140°	90-260V	66	Aluminio + Cristal Templado
15-0100-65	100W	6000K	COB <i>bridgelux.</i>	9000	80°x140°	90-260V	66	Aluminio + Cristal Templado
15-0150-65	150W	6000K	COB <i>bridgelux.</i>	13500	80°x140°	90-260V	66	Aluminio + Cristal Templado

TIRAS LED

Flexibles



TIRAS LED

COB
Bajo voltaje
Interiores



FB-43528-*

LED COB

Características

Lúmenes	Luz Cálida WW (3000K) / 990 lm/m Luz Neutra NW (4250K) / 1100 lm/m
Dimensiones	L5000 x W8 x H1.5mm
Consumo	55W (11W/m)
Corte 	4cm
Cantidad de LEDs	352 LEDs/m
Voltaje	24V CD
Corriente	3A (60mA por unidad)
Humedad Relativa	40%~70%
Temp. Ambiente	-20°~45°C
Protección	IP20



3000K



4250K

Accesorios

*Se venden por separado



Fuente de poder
a 24V



F2B-0208
Tira-Tira



F4B-2208
Tira-Cable-Tira



F3B-0218
Tira-Cable



AP-1616
Perfil 90°

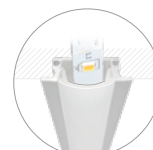

AP-2507
Perfil arco



AP-2811
Perfil recto

MONOCROMÁTICAS

Bajo voltaje
Interiores

TIRAS LED



FB-72282-*
2835 Top LED (0.2)W



FB-43282-*
2835 Top LED (0.2)W

Características

Lúmenes	Luz Cálida WW (3000K) / 1080 lm/m Luz Neutra NW (4000K) / 1320 lm/m
Dimensiones	L5000 x W8 x H1.5mm
Unidad / Corte	6 LEDs / 10cm
Consumo	72W (14.4W/m)
Cantidad de LEDs	300 LEDs (60LEDs/m)
Voltaje	24V CD
Corriente	3A (60mA por unidad)
Humedad Relativa	40%~70%
Temp. Ambiente	-20°~45°C
Protección	IP20

Características

Lúmenes	Luz Cálida WW (3000K) / 684 lm/m Luz Neutra NW (4000K) / 792 lm/m
Dimensiones	L5000 x W8 x H1.5mm
Unidad / Corte	6 LEDs / 16.5cm
Consumo	43.2W (8.64W/m)
Cantidad de LEDs	180 LEDs (36LEDs/m)
Voltaje	24V CD
Corriente	1.8A (60mA por unidad)
Humedad Relativa	40%~70%
Temp. Ambiente	-20°~45°C
Protección	IP20



3000K



4000K



3000K



4000K

Accesorios

*Se venden por separado



Fuente de poder
a 24V



FLS-2820
Conector
Tira-Tira

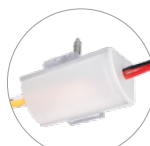

AP-1616
Perfil 90°



AP-2507
Perfil arco



AP-2811
Perfil recto

TIRAS LED

MONOCROMÁTICAS

Bajo voltaje
Exteriores



FE-43287-*

2835 Top LED (0.2W)

Características

Lúmenes	Luz Cálida WW (3000K) / 684 lm/m Luz Neutra NW (4000K) / 792 lm/m
Dimensiones	L5000 x W10 x H4mm
Unidad / Corte	6 LEDs / 16.5cm
Consumo	43.2W (8.64W/m)
Cantidad de LEDs	180 LEDs (36LEDs/m)
Voltaje	24V CD
Corriente	1.8A (60mA por unidad)
Humedad Relativa	40%~70%
Temp. Ambiente	-20°~45°C
Protección	IP67



FE-72287-*

2835 Top LED (0.2W)

Características

Lúmenes	Luz Cálida WW (3000K) / 1320 lm/m Luz Neutra NW (4000K) / 1080 lm/m Luz Fría CW (6000K) / 1320 lm/m
Dimensiones	L5000 x W10 x H4mm
Unidad / Corte	6 LEDs / 10cm
Consumo	72W (14.4W/m)
Cantidad de LEDs	300 LEDs (60LEDs/m)
Voltaje	24V CD
Corriente	3A (60mA por unidad)
Humedad Relativa	40%~70%
Temp. Ambiente	-20°~45°C
Protección	IP67



3000K



4000K



3000K



4000K



6000K

Accesorios

*Se venden por separado



Fuente de poder a 24V

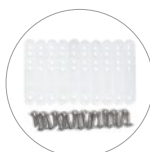

CP-51800
10 Fajos de fijación y 20 tornillos



WP-1000
Pegamento



F1-0110
Conector Tira-Cable



F2-0210
Conector Tira-Tira



AP-1616
Perfil 90°



AP-2507
Perfil arco



AP-2811
Perfil recto

MONOCROMÁTICAS

Bajo voltaje
Exteriores

TIRAS LED



FS-43285-*

2835 Top LED (0.2)W

Características

Lúmenes	Luz Cálida WW (3000K) / 684 lm/m Luz Neutra NW (4000K) / 792 lm/m
Dimensiones	L5000 x W8 x H2.5mm
Unidad / Corte ✂	6 LEDs / 16.5cm
Consumo	43.2W (8.64W/m)
Cantidad de LEDs	180 LEDs (36LEDs/m)
Voltaje	24V CD
Corriente	1.8A (60mA por unidad)
Humedad Relativa	40%~70%
Temp. Ambiente	-20°~45°C
Protección	IP54



3000K



4000K

Accesorios

*Se venden por separado



Fuente de poder a 24V



FLS-1054-8MM
Conector Tira-Cable-Tira



FLS-102B-2
Conector Tira-Cable



FLS-102-C
Conector Tira-Tira



FLS-102-FD2
Conector Tira-Cable-Tira



AP-1616
Perfil 90°



AP-2507
Perfil arco



AP-2811
Perfil recto

CAMBIO DE TEMPERATURA DE COLOR

Bajo voltaje
Exteriores



FS-48356-TC

2016 Top LED (0.2W)

Características

Lúmenes	576Lm/m @2500K 672Lm/m @6000K
Dimensiones	L5000 x W10 x H1.3mm
Unidad / Corte ✂	6 LEDs / 10cm
Consumo	48W (9.6W/m)
Cantidad de LEDs	600 LEDs (120LEDs/m)
Voltaje	24V CD
Corriente	2A (40mA por unidad)
Humedad Relativa	40%~70%
Temp. Ambiente	-20°~45°C
Protección	IP65

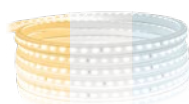

Temperatura de Color ajustable

Accesorios

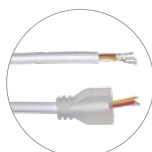

Cable de conexión
incluido

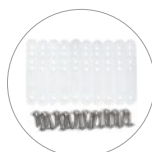

CP-51800
10 Fajos de fijación
y 20 tornillos incluidos



WP-1000
Pegamento
Se vende por separado

RGB / RGBW

Bajo voltaje
Exteriores

TIRAS LED



FS-0036-RGB

5050 Top LED

Características

Lúmenes	RGB (Cambio de color)
Dimensiones	L5000 x W10 x H3mm
Unidad / Corte	6 LEDs / 16.5cm
Consumo	8.6W/m (43.2W/5m)
Cantidad de LEDs	180 LEDs (36LEDs/m)
Voltaje	24V CD
Corriente	2.4A (80mA por unidad)
Humedad Relativa	40%~70%
Temp. Ambiente	-20°~45°C
Protección	IP54



FS-9655-RGBW

RGBW Top LED

Características

Lúmenes	RGB + NW (4000K luz neutra) / 1008 lm/m
Dimensiones	L5000 x W12 x H2.3mm
Unidad / Corte	6LEDs / 10cm
Consumo	96W (19.2 W/m)
Cantidad de LEDs	300 LEDs (60LEDs/m)
Voltaje	24V CD
Corriente	4A (80mA por unidad)
Humedad Relativa	40%~70%
Temp. Ambiente	-20°~45°C
Protección	IP54



RGB



RGBW

Accesorios

*Se venden por separado



Fuente de poder a 24V



AP-1616 Perfil 90°



AP-2507 Perfil arco



AP-2811 Perfil recto



M8+M4-5A Controlador



WIFI-106 Receptor



F4-5A Receptor



CP-51800 10 Fajos de fijación y 20 tornillos

FS-0036-RGB

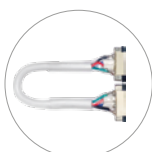

FLS-103-D Conector Tira-Cable-Tira



FLS-1054-10RGB Conector Tira-Cable-Tira



FLS-2854-10RGB Conector Tira-Tira

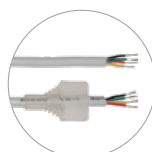

TR-1014 Conector Tira-Cable-Tira



M6+RGB-33A Controlador

TIRAS LED



FC-43286-*

2835 Top LED (0.2W)



Características

Lúmenes	Luz Cálida WW (3000K) / 544 lm/m Luz Neutra NW (4000K) / 544 lm/m
Dimensiones	L5000 x W12 x H4.5mm
Unidad / Corte	6 LEDs / 16.5cm
Consumo	43.2W (8.64W/m)
Cantidad de LEDs	180 LEDs (36LEDs/m)
Voltaje	24V CD
Corriente	1.8A (60mA por unidad)
Humedad Relativa	40%~70%
Temp. Ambiente	-20°~45°C
Protección	IP68



3000K



4000K

SUMERGIBLES

Bajo voltaje



FS-1036-RGB

5050 Top LED



Características

Lúmenes	RGB (Cambio de color)
Dimensiones	L5000 x W12 x H4.5mm
Unidad / Corte	6 LEDs / 16.5cm
Consumo	43.2W (8.64W/m)
Cantidad de LEDs	300 LEDs (60LEDs/m)
Voltaje	24V CD
Corriente	2.4A (80mA por unidad)
Humedad Relativa	40%~70%
Temp. Ambiente	-20°~45°C
Protección	IP68



RGB

Accesorios

Incluidos

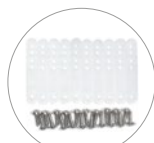

CP-51800
10 Fajos de fijación
y 20 tornillos



2 mangas
termoretráctiles



Conector
inicial

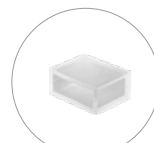

Tapa final

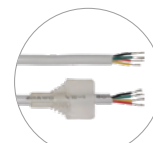

FS-1036-RGB
Incluido

TR-1014
Conector
Tira-Cable-Tira

*Se venden por separado



Fuente de poder
a 24V



WP-1000
Pegamento

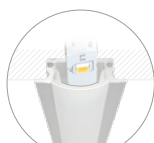

AP-2507
Perfil arco
No apto para
FS-1036-RGB



AP-1616
Perfil 90°



AP-2811
Perfil recto

110V

TIRAS LED



FV-48110-*

2835 Top LED



FS-27352-*

3528 Top LED

Características

Lúmenes	Luz Cálida WW (3000K) / 615 lm/m Luz Neutra NW (4000K) / 615 lm/m
Dimensiones	W100xH70mm, Rollo con L50m
Unidad / Corte	30 LEDs / 50cm
Consumo	480W (9.6W/m)
Cantidad de LEDs	60 LEDs/m
Voltaje	110V AC
Corriente	1.8A (60mA por unidad)
Humedad Relativa	40%~70%
Temp. Ambiente	-20°~45°C
Protección	IP65

Se vende por metro o al comprar rollo, incluye kit de instalación: SET-48110



3000K



4000K

Características

Lúmenes	Luz Cálida WW (3000K) / 615 lm/m Luz Fría CW (6000K) / 230 lm/m
Dimensiones	W110xH75mm, Rollo con L50m
Unidad / Corte	6 LEDs / 16.5cm
Consumo	180W (3.6W/m)
Cantidad de LEDs	60 LEDs (36LEDs/m)
Voltaje	110V AC
Corriente	1.8A (60mA por unidad)
Humedad Relativa	40%~70%
Temp. Ambiente	-20°~45°C
Protección	IP44

Se vende por metro o al comprar rollo, incluye kit de instalación: SET-48110



3000K



6000K

Accesorios

*Se venden por separado



SET-48110
Kit de instalación

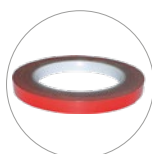

AT-2011
Cinta doble cara



CP-27352
Clip de sujeción

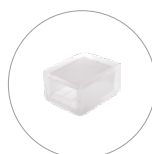

EC-27352
Tapa final



WP-1000
Pegamento

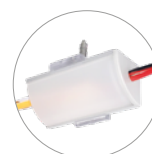

AP-1616
Perfil 90°



AP-2811
Perfil recto

TIRAS LED

Materiales:

1. Perfil de aluminio 6063 con aleación de óxido en la superficie.
2. Difusor de PC opalino.
3. Tapa de plástico.
4. Grapa de plástico o acero inoxidable.
5. Accesorios incluidos. También se venden por separado.

AP-1616

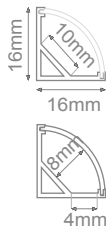

*Longitud: 2m

AP-2507

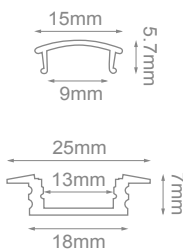

*Longitud: 2m

AP-2011

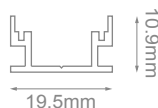

*Longitud: 2m

AP-2811

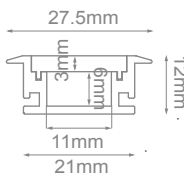

*Longitud: 2m

PERFILES

Acabados

-07 Negro -12 Aluminio

Accesorios



TAP-1616
Par de tapas
finales



CLIP-1616
Par de grapas
y tornillos



TAP-2507
Par de tapas
finales



CLIP-2507
Par de grapas
y tornillos

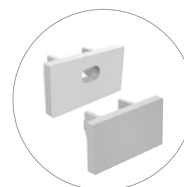

Par de tapas
finales

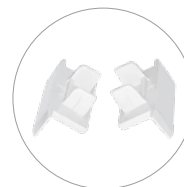

TAP-2811
Par de tapas
finales

ACCESORIOS



ACCESORIOS

FUENTES DE PODER



Fuente de poder	PS-12025
Poder de carga	25W
Voltaje de entrada	90-137 VCA
Voltaje de salida	12V CD
Temp. de operación	-20°~60°C / 20%~90%
Dimensiones	L85 x W58 x H38mm
Protección	IP20 Uso interior



Fuente de poder	PS-12050	PS-24050
Poder de carga	50W	
Voltaje de entrada	90-137 V CA	
Voltaje de salida	12V CD	24V CD
Temp. de operación	-20°~60°C / 20%~90%	
Dimensiones	L110 x W78 x H35mm	
Protección	IP20 Uso interior	



Fuente de poder	PS-12100	PS-24100
Poder de carga	100W	
Voltaje de entrada	90-137 V CA	
Voltaje de salida	12V CD	24V CD
Temp. de operación	-20°~60°C / 20%~90%	
Dimensiones	L159 x W97 x H38mm	
Protección	IP20 Uso interior	

FUENTES DE PODER

ACCESORIOS



Fuente de poder	PS-12150	PS-24150
Poder de carga	150W	
Voltaje de entrada	90-137 V CA	
Voltaje de salida	12V CD	24V CD
Temp. de operación	-20°~60°C / 20%~90%	
Dimensiones	L199 x W98 x H42mm	
Protección	IP20 Uso interior	



Fuente de poder	PS-12250	PS-24250
Poder de carga	250W	
Voltaje de entrada	90-137 V CA (Cambia con Switch)	
Voltaje de salida	12V CD	24V CD
Temp. de operación	-20°~60°C / 20%~90%	
Dimensiones	L200 x W110 x H50mm	
Protección	IP20 Uso interior	



Fuente de poder	PS-24400
Poder de carga	400W
Voltaje de entrada	90-137 VCA
Voltaje de salida	24V CD
Temp. de operación	-20°~60°C / 20%~90%
Dimensiones	L215 x W115 x H50mm
Protección	IP20 Uso interior

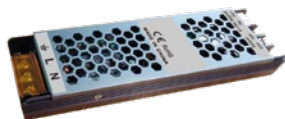

Fuente de poder	PS-12100-D	PS-24100-D
Poder de carga	100W	
Voltaje de entrada	100-264 V 50-60Hz	
Voltaje de salida	12V / 6.6A	24V
Temp. de operación	-20°~60°C / 20%~90%	
Dimensiones	L191 x W48 x H29mm	
Protección	IP20 Uso interior	



Fuente de poder	PS-12150-D	PS-24150-D
Poder de carga	150W	
Voltaje de entrada	100-264 V 50-60Hz	
Voltaje de salida	12V / 12.5A	24V
Temp. de operación	-20°~60°C / 20%~90%	
Dimensiones	L231 x W48 x H29mm	
Protección	IP20 Uso interior	



Fuente de poder	PS-12250-D	PS-24250-D
Poder de carga	250W	
Voltaje de entrada	100-264 V 50-60Hz	
Voltaje de salida	12V / 20.8A	24V
Temp. de operación	-20°~60°C / 20%~90%	
Dimensiones	L287 x W48 x H30mm	
Protección	IP20 Uso interior	

TRANSFORMADORES

ACCESORIOS



Transformador	TRA-1245
Poder de carga	Máx. 45W
Voltaje de entrada	90~137V CA
Voltaje de salida	12V CD
Temp. de operación	-20°~60°C / 20%~90%
Protección	IP67
Dimensiones	L160 x W52 x H32mm



Transformador	TRA-2430
Poder de carga	30W
Voltaje de entrada	90~137V CA
Voltaje de salida	24V CD / 2.5A
Frecuencia	47~63Hz
Temp. de operación	-20°~60°C / 20%~90% HR
Protección	IP67
Dimensiones	L222 x W30 x H20mm



Transformador	TRA-2460
Poder de carga	Máx. 60W
Voltaje de entrada	90~137V CA
Voltaje de salida	24V CD
Frecuencia	47~63Hz
Temp. de operación	-20°~60°C / 20%~90% HR
Protección	IP67
Dimensiones	L175 x W72 x H45mm



Transformador	TRA-1250
Poder de carga	Máx. 50W
Voltaje de entrada	127V CA
Voltaje de salida	12V CA para foco MR16
Protección	IP65

ACCESORIOS

TRANSFORMADORES



Transformador	TRA-12100	TRA-24100
Poder de carga	100W	
Voltaje de entrada	90~137V CA	
Voltaje de salida	12V CD / 8.5A	24V CD / 4.2A
Frecuencia	47~63Hz	
Temp. de operación	-20°~60°C / 20%~90% HR	
Protección	IP67	
Dimensiones	L207 x W66 x H44mm	



Transformador	TRA-12200	TRA-24200
Poder de carga	200W	
Voltaje de entrada	90~137V CA	
Voltaje de salida	12V CD / 16.5A	24V CD / 8.3A
Frecuencia	47~63Hz	
Temp. de operación	-10°~60°C / 20%~90% HR	
Protección	IP67	
Dimensiones	L 225 x W120 x H55mm	



Líderes en control LED

2022

www.astroled.com.mx

EX

Paneles Touch
100-240V AC

Control de 1 Zona

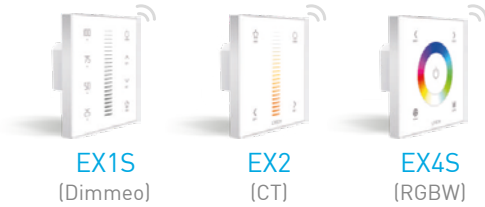

Control de Multizona

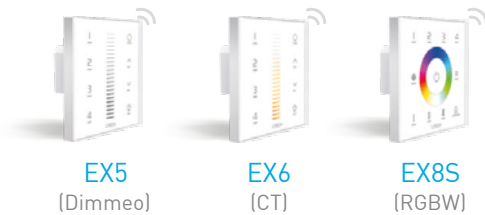

EXC

Paneles Touch
100-240V AC

Control de Atenuación



WiFi-106

Control por red WiFi
12~24VDC

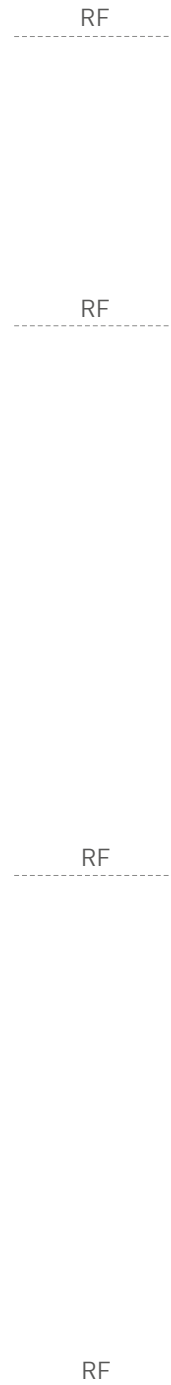

----- Conexión inalámbrica
———— Cableado

*RF: Radio Frecuencia 2.4 GHZ

Receptores L-BUS®



F4-5A



F4-CC

Especificaciones

Modelo	F4-5A	F4-CC
Nombre	CV LED driver inalámbrico	CC LED driver inalámbrico
Señal inalámbrica	RF 2.4GHz	
Señal analógica	5-24V DC	18-48V DC
Voltaje de salida	5-24V DC	3-46V DC
Corriente de entrada	5A x 4CH Máx. 20A	CC 350/700/1050mA x 4 CH
Corriente de salida	(0-25W...120W) x 4CH Máx. 480W	(1.05W-48.3W) x 4CH Máx. 193.2W
Protección	Sobrecorriente / sobrecalentamiento / cortocircuito / circuito abierto / conexión de protección inversa, se recupera automáticamente. IP20	
Temp. de Operación:	-30°C ~ 55°C	
Dimensiones	L175xW44xH30mm	

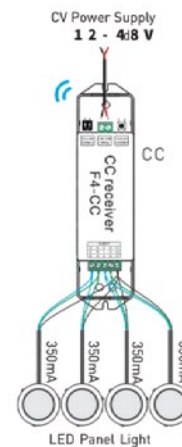
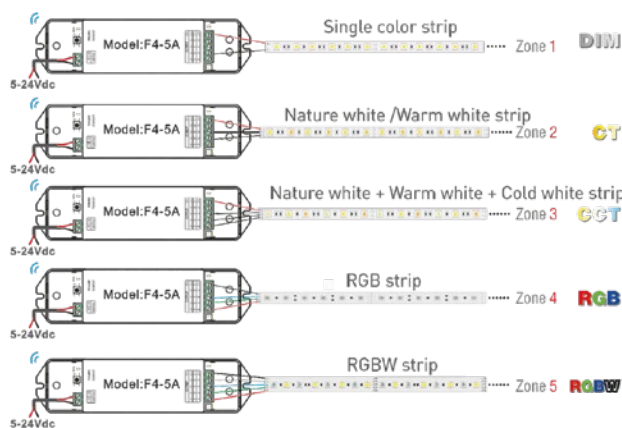

Paneles Touch L-BUS®

EX

Control de 1 zona



EX1S
(Dimmeo)



EX2
(CT)

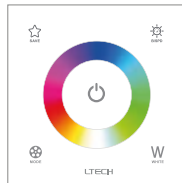

EX4S
(RGBW)

Control de Multizona



EX5
(Dimmeo)



EX6
(CT)



EX8S
(RGBW)

Especificaciones

Modelo	EX1S	EX2	EX4S	EX5	EX6	EX8S
Control	Dimmeo	CT	RGBW	Dimmeo	CT	RGBW
Zonas	1 zona			4 zonas		
Voltaje de entrada	100-240V AC					
Señal de salida	RF 2.4GHz, DMX512					
Temp. de operación	-20°C~55°C					
Dimensiones	L86×W86×H36(mm)					

EXC

Control de Atenuación

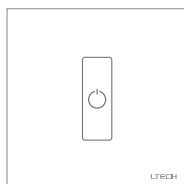

EXC1

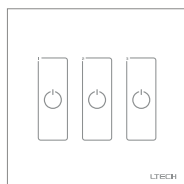

EXC2

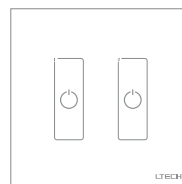

EXC3

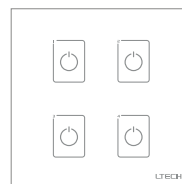

EXC4

Especificaciones

Modelo	EXC1	EXC2	EXC3	EXC4
Canales	1	2	3	4
Voltaje de entrada	100-240V AC			
Señal de salida	RF 2.4GHz, DMX512			
Temp. de operación	-20°C~55°C			
Dimensiones	L113×W112×H50(mm)			

*CT: Temperatura de Color

*Caja de fijación CR-D1 se vende por separado.

WiFi-106 L-BUS®

Control por red WiFi



WiFi-106

- » Señal inalámbrica: 2.4GHz WiFi, Protocolo 802.11b/g/n
- » Voltaje de entrada: 12~24VDC
- » Corriente de Salida: 4Ax4CH Máx.16A
- » Máx. Poder de Salida: [0~48W...96W] x 4CH Max:348W
- » Control de Salida: CT, Atenuación, RGB, RGBW
- » Temp. de operación: -30°~55°C
- » Dimensiones: L128xW73xH45[mm]

Control Remoto - F12

- » Voltaje de Operación: 3VCD [Batería CR2032]
- » Frecuencia Wireless: RF 2.4GHz

Repetidores L-BUS®

Inalámbricos



EBOX-AP

- » Señal inalámbrica: RF 2.4GHz
- » Voltaje de entrada: 5-24V DC
- » Alcance: 30m
- » Corriente: Máx. 1.2A
- » Temp. de operación: -30°C~55°C
- » Dimensiones: L55xW55xH21[mm]



EBOX-TD

- » Señal inalámbrica: RF 2.4GHz
- » Voltaje de entrada: 100~240V AC
- » Dimeo: ELV
- » Corriente: Máx. 1.2A
- » Poder: LEDs Dimeables: Máx. 150W
- » Temp. de operación: Ta: -30°C~55°C Tc: 65°C
- » Dimensiones: L55xW55xH21[mm]

Repetidores L-BUS®



REP-3063 Sumergible RGB y Dimers de bajo voltaje CC y CV

- » Voltaje de entrada 5~24V DC
- » Corriente de entrada 3A x 3CH Máx. 9A
- » Corriente de salida Máx. 45W/108W/216W (5V/12V/24V)
- » Poder de salida 108W a 12V, 216W a 24V
- » Protección IP68
- » Temp. de operación: -30°C ~ +65°C
- » Dimensiones L181xW35xH28mm



REP-3060 RGB y Dimers de bajo voltaje CC y CV

- » Señal de entrada PWM (200Hz-2000Hz)
- » Voltaje de entrada 5~24V DC
- » Corriente de entrada 5A x 3CH Máx. 15A
- » Poder de salida (0~25W...120W) x 3CH Máx. 360W
- » Protección IP20
- » Temp. de operación: -30°C ~ 55°C
- » Dimensiones L121xW39xH39mm



REP-3070 RGB y Dimers de bajo voltaje CC y CV

- » Señal de entrada PWM
- » Voltaje de entrada 12~48V DC
- » Corriente de entrada 8A x 3CH Máx. 24A
- » Poder de salida 288W / 576W / 864W / 1152W (12V / 24V / 36V / 48V)
- » Temp. de operación: -30°C ~ 65°C
- » Dimensiones L148xW87xH31mm



REP-3040-5A RGB y Dimers de bajo voltaje CC y CV

- » Señal de entrada PWM (200Hz-2000Hz)
- » Voltaje de entrada 5~24V DC
- » Corriente de entrada 5A x 4CH Máx. 20A
- » Poder de salida (0~25W...120W) x 3CH Máx. 480W
- » Temp. de operación: -30°C ~ 55°C
- » Dimensiones L178xW48xH33mm

K1/K2 Switch Paneles Touch

Serie de panel inteligente touch

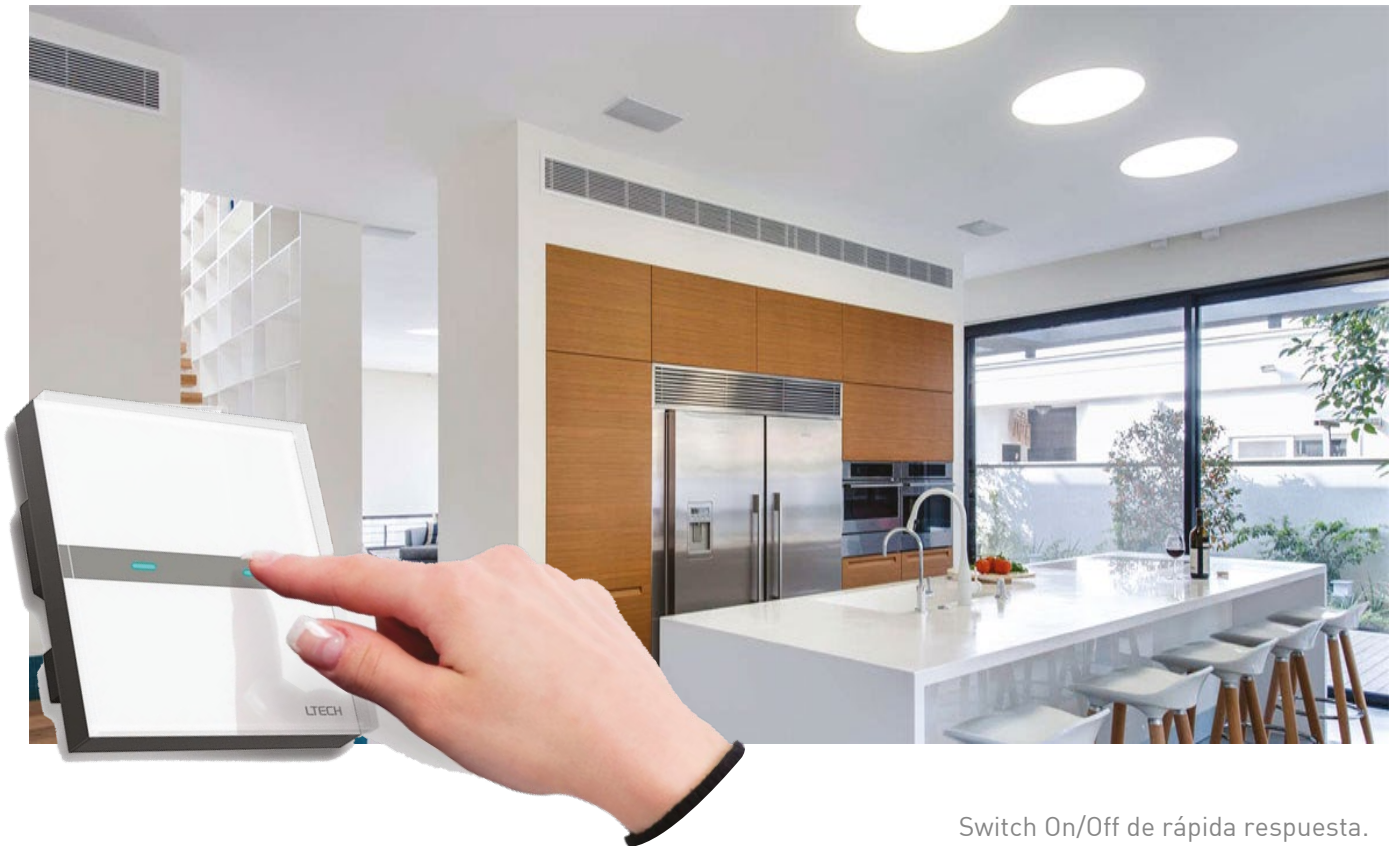

Switch On/Off de rápida respuesta. Encienda o apague la luz de cualquier habitación con tan solo un suave y delicado toque.



K1



K2

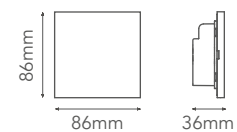

Especificaciones

Modelo	K1	K2
Voltaje de entrada	220V AC, 50Hz	
Tipo de carga	Lámparas incandescente, fluorescentes y LED	
Poder de carga	Máx. 200WxCH Mín. 5WxCH	
Temp. de operación	-20°C-55°C	
Dimensiones	L86xW36xH86mm	



Caja de fijación CR-D1
*Se vende por separado

Mini RF Wireless



3 controles remotos distintos,
1 receptor



Controladores M3-3A

» Voltaje de entrada	DC12V-DC24V
» Corriente de Carga	Máx. 3A x 3CH
» Máx. Poder de Salida	108W/216W (12V/24V)
» Temp. de operación	-30°~55°C
» Dimensiones	L135xW30xH20mm

Mini Controles en Kit

Inncluyen Control Remoto + Controlador.



M1+RGB-33A

CR Dimeo



M2+RGB-33A

CR Temp. de color



M6+RGB-33A

Cambio de Color



Mini para RGBW M8+M4-5A

Cambio de Color



RGB-3600

- » Controlador RGB, 32 Secuencias, con memoria: 4 escenas
- » Incluye control remoto
- » Voltaje de entrada DC12V-DC24V
- » Máx. poder de salida: 216W/432W(12V/24V)
- » Dimensiones: L211xW40xH30(mm)

D series Panel Touch

Bajo Voltaje



DIM-D1

- » Voltaje de entrada DC12V~DC24V
- » Máx. corriente de carga 4A x 3CH Máx. 12A
- » Máx. poder salida 144W/288W (12V/24V)
- » Nivel escala grises 4096
- » Temp. de Operación -20° ~ 60°C
- » Dimensiones L86×W86×H36mm



Caja de fijación CR-D1
*Se vende por separado

Diagrama de Cableado

Ejemplo de Cableado 1: Conexión con tira 12V, Máx. 144W(12V)



Ejemplo de Cableado 2: Conexión con tira 24V, Máx. 288W(24V)

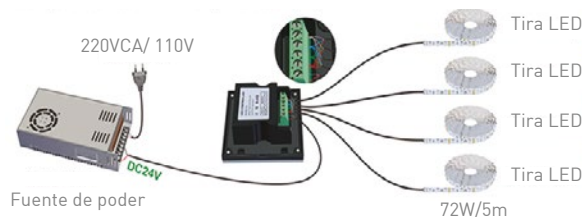

Astro Iluminación

GARANTÍA LIMITADA

Por un período de 3 años a partir de la fecha de compra. Astro LED Lighting, garantiza este producto, contra cualquier defecto en cuanto a materiales utilizados y a la elaboración.

En caso de alguna falla de este producto contemplada dentro de la garantía, AstroLED Lighting, reparará la unidad o proveerá un repuesto para la unidad y componentes del mismo, sin costo adicional para el cliente. Si después de ser probado y examinado, se comprueba que el producto no está dentro de las condiciones de garantía, todos los costos de instalación, traslado o reinstalación serán responsabilidad del comprador.

Por reclamo de garantía, el comprador debe regresar el producto pagando por adelantado el servicio de traslado a las instalaciones de OV Iluminación, S.A. de C.V. Ubicada en Calzada de los Paraísos No. 7205 Col. Ciudad Granja, Zapopan, Jal. C.P. 45010, Dentro de los siguientes 30 días de la fecha de la elaboración de la factura. Si nuestras pruebas y exámenes demuestran que están dentro de la garantía se expedirá una nota de crédito. Esta garantía es válida sólo para el comprador original de la unidad y no para algún comprador posterior. Esta garantía no cubre defectos, mal funcionamiento, o fallas causadas por reparaciones hechas mientras esté la unidad en poder del comprador, por falta de mantenimiento necesario o por mal uso del producto.

ESTA GARANTÍA LE BRINDA DERECHOS LEGALES ESPECÍFICOS Y USTED PODRÍA TENER OTROS DERECHOS QUE VARÍAN DE ESTADO A ESTADO.

LIMITACIONES Y EXCLUSIONES

Esta garantía está limitada a lo antes mencionado. Ésta, y cualquier otra garantía implícita por la leyes estatales, se aplicará solamente por el periodo de 3 años. Astro LED Lighting, no será responsable por ninguna pérdida o cualquier daño accidental o conciente de cualquier clase, ya sea basado en la garantía, contrato o negligencia y de alguna manera concertado con la venta, uso o reparación de este producto. A menos que haya alguna modificación a la ley, la máxima responsabilidad de OV Iluminación, S.A. de C.V. , no deberá exceder en ningún caso el precio del producto reclamado como defectuoso.

Impreso en Marzo de 2023

Actualizaciones digitales en www.astroled.com.mx



www.astroled.com.mx

 Facebook: [astroledlighting](https://www.facebook.com/astroledlighting)

